

MANUAL

GB Oscilloscope
HM404

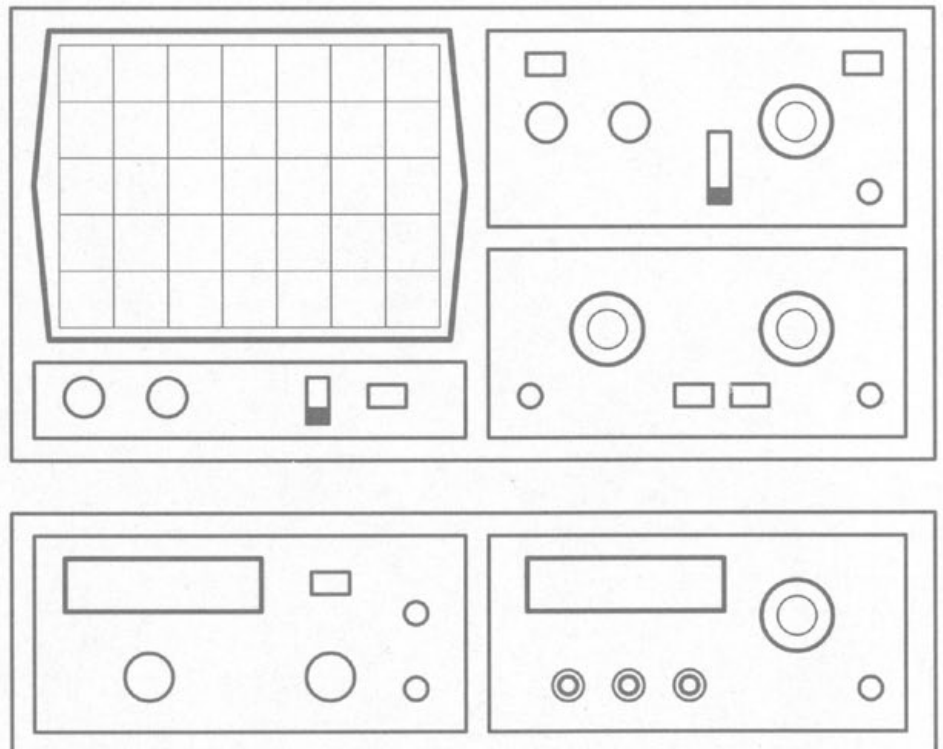

General information regarding the CE marking 2

General Information 4

Symbols 4
 Use of tilt handle 4
 Safety 4
 Intended purpose and operating conditions 4
 EMC 5
 Warranty 5
 Maintenance 5
 Protective Switch-Off 5
 Power supply 5
 Type of signal voltage 6
 Amplitude Measurements 6
 Total value of input voltage 7
 Time Measurements 7
 Connection of Test Signal 8

Controls and Readout 9

Menu 17

First Time Operation 17
 Trace Rotation TR 18
 Probe compensation and use 18
 Adjustment at 1kHz 18
 Adjustment at 1MHz 18
 Operating modes of the vertical amplifiers in Yt mode. 19
 X-Y Operation 19
 Phase comparison with Lissajous figures 19
 Phase difference measurement in DUAL mode (Yt) 20
 Phase difference measurement in DUAL mode 20
 Measurement of an amplitude modulation 20

Triggering and timebase 21

Automatic Peak (value) -Triggering 21
 Normal Triggering 21
 SLOPE \wedge 21
 Trigger coupling 22
 Triggering of video signals 22
 Line triggering (~) 22
 Alternate triggering 23
 External triggering 23
 Trigger indicator „TR“ 23
 HOLD OFF-time adjustment 23
 Delay / After Delay Triggering 24

AUTO SET 25

SAVE/RECALL 26

Component Tester 26

General 26
 Using the Component Tester 26

Test Procedure 26

Test Pattern Displays 26
 Testing Resistors 26
 Testing Capacitors and Inductors 26
 Testing Semiconductors 26
 Testing Diodes 27
 Testing Transistors 27
 In-Circuit Tests 27

GB Oscilloscope HM404

Test Instructions 27

General 27
 Cathode-Ray Tube: Brightness and Focus, Linearity, Raster Distortion 28
 Astigmatism Check 28
 Symmetry and Drift of the Vertical Amplifier 28
 Calibration of the Vertical Amplifier 28
 Transmission Performance 28
 of the Vertical Amplifier 28
 Operating Modes: CH.I/II, DUAL, ADD, CHOP., INVERT and X-Y Operation 29
 Triggering Checks 29
 Timebase 29
 Hold Off time 30

Component Tester 30

Trace Alignment 30

Service Instructions 30

General 30
 Instrument Case Removal 30
 Caution 30
 Operating Voltages 30
 Maximum and Minimum Brightness 30
 Astigmatism control 31
 Trigger Threshold 31
 Trouble-Shooting the Instrument 31
 Adjustments 31

RS232 Interface - Remote Control 31

Safety 31
 Operation 31
 Baud-Rate Setting 32
 Data Communication 32

Front panel HM404 32

St. 050298-Hub/goRR



Herstellers
Manufacturer
Fabricant

HAMEG GmbH
Keilsterbacherstraße 15-19
D - 60528 Frankfurt

KONFORMITÄTSERKLÄRUNG
DECLARATION OF CONFORMITY
DECLARATION DE CONFORMITE

HAMEG[®]
Instruments

Bezeichnung / Product name / Designation:

Oszilloskop/Oscilloscope/Oscilloscope

Typ / Type / Type: **HM404**

mit / with / avec: -

Optionen / Options / Options: -

mit den folgenden Bestimmungen / with applicable regulations / avec les directives suivantes

EMV Richtlinie 89/336/EWG ergänzt durch 91/263/EWG, 92/31/EWG
EMC Directive 89/336/EEC amended by 91/263/EWG, 92/31/EEC
Directive EMC 89/336/CEE amendée par 91/263/EWG, 92/31/CEE

Niederspannungsrichtlinie 73/23/EWG ergänzt durch 93/68/EWG
Low-Voltage Equipment Directive 73/23/EEC amended by 93/68/EEC
Directive des équipements basse tension 73/23/CEE amendée par 93/68/CEE

Angewendete harmonisierte Normen / Harmonized standards applied / Normes harmonisées utilisées

Sicherheit / Safety / Sécurité

EN 61010-1: 1993 / IEC (CEI) 1010-1: 1990 A 1: 1992 / VDE 0411: 1994
Überspannungskategorie / Overvoltage category / Catégorie de surtension: II
Verschmutzungsgrad / Degree of pollution / Degré de pollution: 2

Elektromagnetische Verträglichkeit / Electromagnetic compatibility
Compatibilité électromagnétique

EN 50082-2: 1995 / VDE 0839 T82-2
ENV 50140: 1993 / IEC (CEI) 1004-4-3: 1995 / VDE 0847 T3
ENV 50141: 1993 / IEC (CEI) 1000-4-6 / VDE 0843 / 6
EN 61000-4-2: 1995 / IEC (CEI) 1000-4-2: 1995 / VDE 0847 T4-2
Prüfschärfe / Level / Niveau = 2

EN 61000-4-4: 1995 / IEC (CEI) 1000-4-4: 1995 / VDE 0847 T4-4:
Prüfschärfe / Level / Niveau = 3

EN 50081-1: 1992 / EN 55011: 1991 / CISPR11: 1991 / VDE0875 T11: 1992
Gruppe / group / groupe = 1, Klasse / Class / Classe = B

Datum / Date / Date
18.11.1997

Unterschrift / Signature / Signatur

Dr. J. Herzog
Technical Manager/Directeur Technique

General information regarding the CE marking

HAMEG instruments fulfill the regulations of the EMC directive. The conformity test made by HAMEG is based on the actual generic- and product standards. In cases where different limit values are applicable, HAMEG applies the severer standard. For emission the limits for residential, commercial and light industry are applied. Regarding the immunity (susceptibility) the limits for industrial environment have been used.

The measuring- and data lines of the instrument have much influence on emission and immunity and therefore on meeting the acceptance limits. For different applications the lines and/or cables used may be different. For measurement operation the following hints and conditions regarding emission and immunity should be observed:

1. Data cables

For the connection between instruments resp. their interfaces and external devices, (computer, printer etc.) sufficiently screened cables must be used. Without a special instruction in the manual for a reduced cable length, the maximum cable length of a dataline must be less than 3 meters long. If an interface has several connectors only one connector must have a connection to a cable.

Basically interconnections must have a double screening. For IEEE-bus purposes the double screened cables HZ72S and HZ72L from HAMEG are suitable.

2. Signal cables

Basically test leads for signal interconnection between test point and instrument should be as short as possible. Without instruction in the manual for a shorter length, signal lines must be less than 3 meters long.

Signal lines must be screened (coaxial cable - RG58/U). A proper ground connection is required. In combination with signal generators double screened cables (RG223/U, RG214/U) must be used.

3. Influence on measuring instruments.

Under the presence of strong high frequency electric or magnetic fields, even with careful setup of the measuring equipment an influence of such signals is unavoidable.

This will not cause damage or put the instrument out of operation. Small deviations of the measuring value (reading) exceeding the instruments specifications may result from such conditions in individual cases.

HAMEG GmbH

The new microprocessor controlled 40MHz Analog-Oscilloscope HM404

Auto-Set, Save / Recall, Readout / Cursor, Remote control via built-in RS-232 Interface

Specifications

Vertical Deflection

Operating modes: Channel I or CH II separate, Channel I and II: alternate or chopped (Chopper Frequency approx. 0.5MHz)

Sum or Difference from Channel I and Ch. II, (CH II invertable). XY-Mode: via CH I and CH II.

Frequency range: 2x DC to 40MHz (-3dB).

Risetime: <8.75ns. Overshoot: ≤1%.

Deflection coefficient: 14 calibrated positions from 1mV/div to 20V/div in 1-2-5 sequence, variable 2.5:1 to min. 50V/div.

Accuracy in calibrated positions:

1mV/div to 2mV/div: ±5% (0 to 10MHz (-3dB))

5mV/div to 20V/div: ±3%

Input impedance: 1MΩ || 20pF.

Input coupling: DC - AC - GD (Ground)

Input voltage: max. 400V (DC + peak AC).

Triggering

Automatic(peak to peak): ≤20Hz-100MHz(≤0.5div),

Normal: DC-100MHz, LED for trigger indication.

Slope: positive or negative.

Sources: CH I or II, CH I alternate CH II, line, ext.

Coupling: AC (≥10Hz-100MHz), DC (0-100MHz),

HF (50kHz - 100MHz), LF (0 - ≤1.5kHz).

Triggering ext.: ≥0.3Vpp from DC to 100MHz

Active TV-Sync-Separator (field & line, pos, neg.)

2nd triggering (Del. Trig.): normal with level control DC to 100 MHz.

Horizontal Deflection

Time coefficients: 1-2-5 sequence, Accuracy ±3%

Analog: 22 cal. positions from 0.5s - 50ns/div.

Variable 2.5:1 up to 1.25s/div.

X-MAG.x10: up to 10ns/div. ±5%.

Delay: approx. 140ms - 200ns, variable,

Hold-off time: variable to approx. 10:1.

Bandwidth X-amplifier: 0-3MHz (-3dB).

Input X-amplifier via Channel II,

Sensitivity see Channel II.

X-Y-phase shift: <3° below 220kHz.

Operation / Control

Manual (front panel switches);

Auto Set (automatic parameter selection).

Save/Recall of 10 user-defined parameter settings

RS232 interface for remote control via a PC.

Remote control (Option) HZ68.

Readout: Display of parameter settings.

Cursor measurement of ΔV, Δt or Δ1/t (frequency), separate or in tracking mode.

Component Tester

Test voltage: approx. 7V_{rms} (open circuit).

Test current: max. 7mA_{rms} (short circuit).

Test frequency: approx. 50Hz

One test lead is grounded (Safety Earth).

General Information

CRT: D14-364GY/123 or ER151-GH/-,

rectangular screen (8x10cm) internal graticule

Acceleration voltage: approx 2000V

Trace rotation: adjustable on front panel

Z-Input (Intensity modulation), max. +5V (TTL).

Calibrator: square-wave generator (tr <4ns)

»1kHz/1MHz; Output: 0.2V ±1%.

Line voltage: 100-240V AC ±10%, 50/60Hz

Power consumption: approx. 34 Watt at 50Hz.

Min./Max. ambient temperature: 0°C...+40°C

Protective system: Safety class I (IEC1010-1)

Weight: approx. 5.5kg, color: techno-brown

Cabinet: W 285, H 125, D 380 mm

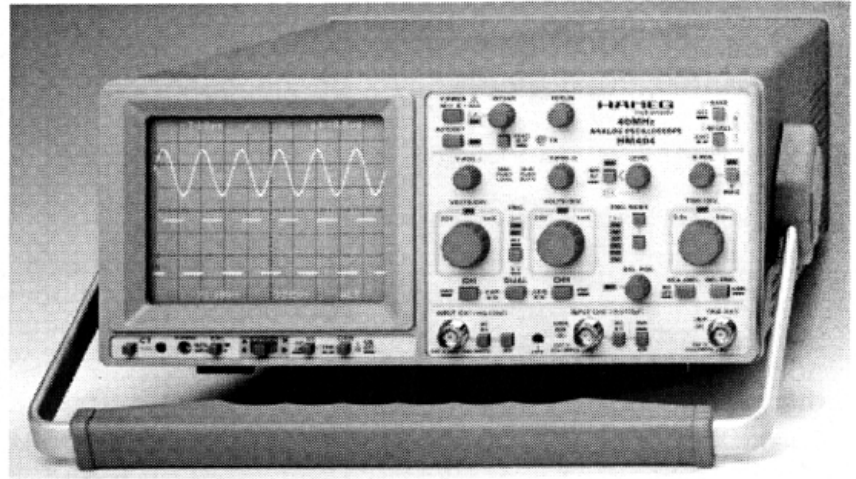

Vertical: 2 Channels, 1mV/div. - 20V/div., Comp.-Tester, 1MHz Calibrator
Time Base: 0.5 s/div. to 10 ns/div.; Trigger-after-delay; Alternate Trigger
Triggering: DC to 100 MHz; Automatic Peak to Peak; TV-Sync-Separator

The **HM404** is **HAMEG's** new **40MHz** microprocessor controlled analog oscilloscope. The internal microprocessor has the capability of **automatically configuring** the oscilloscope parameters, when used in the „**Auto Set**“ mode, so as to present a display of three cycles of the input signal, with all of the proper control settings automatically configured: a single trace will be displayed with 4 to 6 divisions amplitude, while each signal will be 3 to 4 divisions high in dual trace mode. At a touch of the controls, the user can over-ride the automatic settings. Cursors can be activated for waveform measurements. All important parameter settings are displayed on the CRT screen.

One **powerful feature** is the ability to store user-defined test scenarios, that can be called up on demand for repeated measurement tasks. A total of **9 setups** can be **saved and recalled** as many times as required. Additional setup information is possible via the **RS-232** port, which can be controlled from the serial port of a **PC**. The bandwidth of 40MHz (-3dB) allows the stable display of signals **up to 100MHz**.

Although the instrument's vertical bandwidth is specified as 40MHz, signals to 100MHz can be displayed and triggered. Signal expansion up to a factor of 500 times can be obtained in the „Delay“ and „Trigger after Delay“ modes. As always, the **Component Tester** with one-button control is a standard feature in the **HM404**. This is also true for the switchable **1kHz/1MHz Calibrator** which permits you to check the transient characteristics from probe tip to the screen at any time.

A **switching mode power supply** minimises power and results in a lightweight unit weighing only 12.4 pounds (5.6kg). The scope is ideal for fast troubleshooting. The **Auto Set** feature permits the rapid inspection of test points, without the need to constantly adjust the scope for each new test mode. The ability to **Save/Recall** facilitates the use of this unit for final inspections, where multiple, repeated scope settings are required. These capabilities result in labor saving operations which translate to more efficiency and cost savings to the customer.

Color-Burst of a composite TV signal in Delay mode with second triggering

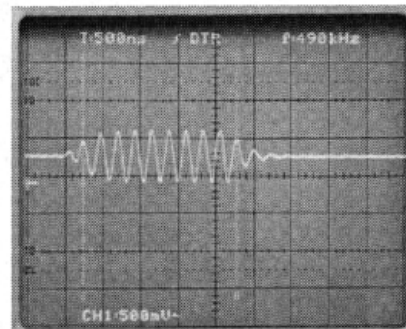

50 and 100MHz signals displayed in alternate DUAL mode and CURSOR supported freq. measurement

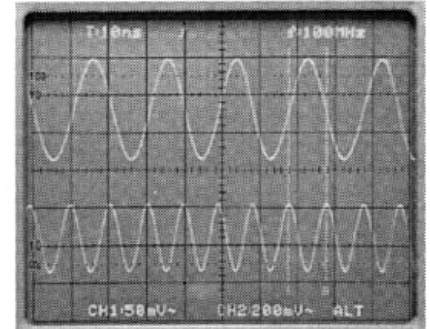

Accessories supplied: Line Cord, Operators Manual, 2 Probes 1:1/ 10:1

Subject to change without notice.

12/97

Subject to change without notice



General Information

General Information

This oscilloscope is easy to operate. The logical arrangement of the controls allows anyone to quickly become familiar with the operation of the instrument, however, experienced users are also advised to read through these instructions so that all functions are understood.

Immediately after unpacking, the instrument should be checked for mechanical damage and loose parts in the interior. If there is transport damage, the supplier must be informed immediately. The instrument must then not be put into operation.

Symbols

-  ATTENTION - refer to manual
-  Danger - High voltage
-  Protective ground (earth) terminal

Use of tilt handle

To view the screen from the best angle, there are three different positions (C, D, E) for setting up the instrument. If the instrument is set down on the floor after being carried, the handle automatically remains in the upright carrying position (A). In order to place the instrument onto a horizontal surface, the handle should be turned to the upper side of the oscilloscope (C). For the D position (10° inclination), the handle should be turned to the opposite direction of the carrying position until it locks in place automatically underneath the instrument. For the E position (20° inclination), the handle should be pulled to release it from the D position and swing backwards until it locks once more. The handle may also be set to a position for horizontal carrying by turning it to the upper side to lock in the B position. At the same time, the instrument must be lifted, because otherwise the handle will jump back.

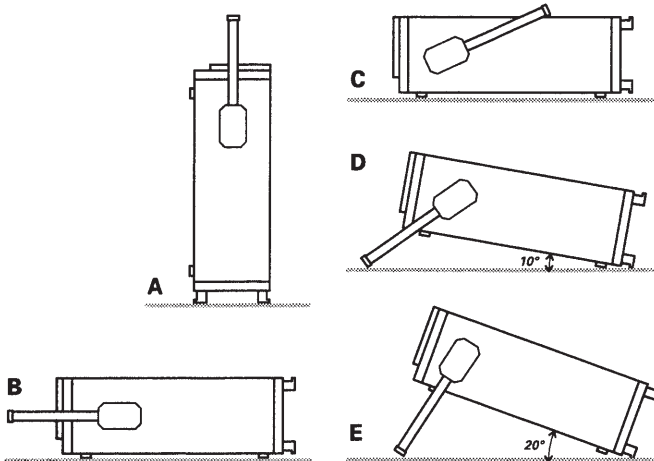

Safety

This instrument has been designed and tested in accordance with IEC Publication 1010-1 (overvoltage category II, pollution degree 2), Safety requirements for electrical equipment for measurement, control, and laboratory use. The CENELEC regulations EN 61010-1 correspond to this standard. It has left the factory in a safe condition. This instruction manual contains important information and warnings which have to be followed by the user to ensure safe operation and to retain the oscilloscope in a safe condition.

The case, chassis and all measuring terminals are connected to the protective earth contact of the appliance inlet. The instrument operates according to Safety Class I (three-conductor power cord with protective earthing conductor and a plug with earthing contact).

The mains/line plug shall only be inserted in a socket outlet provided with a protective earth contact. The protective action must not be negated by the use of an extension cord without a protective conductor.

The mains/line plug must be inserted before connections are made to measuring circuits.

The grounded accessible metal parts (case, sockets, jacks) and the mains/line supply contacts (line/live, neutral) of the instrument have been tested against insulation breakdown with 2200V DC.

Under certain conditions, 50Hz or 60Hz hum voltages can occur in the measuring circuit due to the interconnection with other mains/line powered equipment or instruments. This can be avoided by using an isolation transformer (Safety Class II) between the mains/line outlet and the power plug of the device being investigated.

Most cathode-ray tubes develop X-rays. However, the dose equivalent rate falls far below the maximum permissible value of 36pA/kg (0.5mR/h).

Whenever it is likely that protection has been impaired, the instrument shall be made inoperative and be secured against any unintended operation. The protection is likely to be impaired if, for example, the instrument

- shows visible damage,
- fails to perform the intended measurements,
- has been subjected to prolonged storage under unfavourable conditions (e.g. in the open or in moist environments),
- has been subject to severe transport stress (e.g. in poor packaging).

Intended purpose and operating conditions

This instrument must be used only by qualified experts who are aware of the risks of electrical measurement.

The instrument is specified for operation in industry, light industry, commercial and residential environments.

Due to safety reasons the instrument must only be connected to a properly installed power outlet, containing a protective earth conductor. The protective earth connection must not be broken. The power plug must be inserted in the power outlet while any connection is made to the test device.

The instrument has been designed for indoor use. The permissible ambient temperature range during operation is +10°C (+50°F) ... +40°C (+104°F). It may occasionally be subjected to temperatures between +10°C (+50°F) and -10°C (+14°F) without degrading its safety. The permissible ambient temperature range for storage or transportation is -40°C (-40°F) ... +70°C (+158°F). The maximum operating altitude is up to 2200m (non-operating 15000m). The maximum relative humidity is up to 80%.

If condensed water exists in the instrument it should be acclimatized before switching on. In some cases (e.g. extremely cold oscilloscope) two hours should be allowed before the instrument is put into operation. The instrument should be kept in a clean and dry room and must not be operated in explosive, corrosive, dusty, or moist environ-

ments. The oscilloscope can be operated in any position, but the convection cooling must not be impaired. The ventilation holes may not be covered. For continuous operation the instrument should be used in the horizontal position, preferably tilted upwards, resting on the tilt handle.

The specifications stating tolerances are only valid if the instrument has warmed up for 30 minutes at an ambient temperature between +15°C (+59°F) and +30°C (+86°F). Values without tolerances are typical for an average instrument.

EMC

This instrument conforms to the European standards regarding the electromagnetic compatibility. The applied standards are: Generic immunity standard EN50082-2:1995 (for industrial environment) Generic emission standard EN50081-1:1992 (for residential, commercial and light industry environment). This means that the instrument has been tested to the highest standards.

Please note that under the influence of strong electromagnetic fields, such signals may be superimposed on the measured signals.

Under certain conditions this is unavoidable due to the instrument's high input sensitivity, high input impedance and bandwidth. Shielded measuring cables, shielding and earthing of the device under test may reduce or eliminate those effects.

Warranty

HAMEG warrants to its Customers that the products it manufactures and sells will be free from defects in materials and workmanship for a period of 2 years. This warranty shall not apply to any defect, failure or damage caused by improper use or inadequate maintenance and care. **HAMEG** shall not be obliged to provide service under this warranty to repair damage resulting from attempts by personnel other than **HAMEG** representatives to install, repair, service or modify these products.

In order to obtain service under this warranty, Customers must contact and notify the distributor who has sold the product. Each instrument is subjected to a quality test with 10 hour burn-in before leaving the production. Practically all early failures are detected by this method. In the case of shipments by post, rail or carrier it is recommended that the original packing is carefully preserved. Transport damages and damage due to gross negligence are not covered by the guarantee.

In the case of a complaint, a label should be attached to the housing of the instrument which describes briefly the faults observed. If at the same time the name and telephone number (dialing code and telephone or direct number or department designation) is stated for possible queries, this helps towards speeding up the processing of guarantee claims.

Maintenance

Various important properties of the oscilloscope should be carefully checked at certain intervals. Only in this way is it largely certain that all signals are displayed with the accuracy on which the technical data are based. The test methods described in the test plan of this manual can be performed without great expenditure on measuring instruments. However, purchase of the **HAMEG** scope tester **HZ60**, which despite its low price is highly suitable for tasks of this type, is very much recommended. The exterior of the oscilloscope should be cleaned regularly with a dusting brush. Dirt which is difficult to remove on the casing and handle, the plastic and

aluminium parts, can be removed with a moistened cloth (99% water + 1% mild detergent). Spirit or washing benzene (petroleum ether) can be used to remove greasy dirt. The screen may be cleaned with water or washing benzene (but not with spirit (alcohol) or solvents), it must then be wiped with a dry clean lint-free cloth. Under no circumstances may the cleaning fluid get into the instrument. The use of other cleaning agents can attack the plastic and paint surfaces.

Protective Switch-Off

This instrument is equipped with a switch mode power supply. It has both overvoltage and overload protection, which will cause the switch mode supply to limit power consumption to a minimum. In this case a ticking noise may be heard.

Power supply

The oscilloscope operates on mains/line voltages between 100VAC and 240VAC. No means of switching to different input voltages has therefore been provided.

The power input fuses are externally accessible. The fuseholder is located above the 3-pole power connector. The power input fuses are externally accessible, if the rubber connector is removed. The fuseholder can be released by pressing its plastic retainers with the aid of a small screwdriver. The retainers are located on the right and left side of the holder and must be pressed towards the center. The fuse(s) can then be replaced and pressed in until locked on both sides.

Use of patched fuses or short-circuiting of the fuseholder is not permissible; **HAMEG** assumes no liability whatsoever for any damage caused as a result, and all warranty claims become null and void.

Fuse type:
Size 5x20mm; 0.8A, 250V AC fuse;
must meet IEC specification 127,
Sheet III (or DIN 41 662
or DIN 41 571, sheet 3).
Time characteristic: time-lag (T).

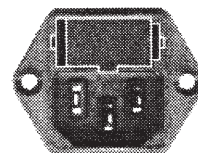

Attention! **There is a fuse located inside the instrument within the switch mode power supply:**

Size 5x20mm; 0.8A, 250V AC fuse;
must meet IEC specification 127,
Sheet III (or DIN 41 662
or DIN 41 571, sheet 3).
Time characteristic: fast (F).

This fuse must not be replaced by the operator!

Type of signal voltage

Type of signal voltage

The oscilloscope **HM404** allows examination of DC voltages and most repetitive signals in the frequency range up to at least 40MHz (-3dB).

The vertical amplifiers have been designed for minimum overshoot and therefore permit a true signal display.

The display of sinusoidal signals within the bandwidth limits causes no problems, but an increasing error in measurement due to gain reduction must be taken into account when measuring high frequency signals. This error becomes noticeable at approx. 14MHz. At approx. 18MHz the reduction is approx. 10% and the real voltage value is 11% higher. The gain reduction error can not be defined exactly as the -3dB bandwidth of the amplifiers differ between 40MHz and 42MHz. For sinewave signals the -6dB limit is approx. 50MHz. When examining square or pulse type waveforms, attention must be paid to the harmonic content of such signals. The repetition frequency (fundamental frequency) of the signal must therefore be significantly smaller than the upper limit frequency of the vertical amplifier.

Displaying composite signals can be difficult, especially if they contain no repetitive higher amplitude content which can be used for triggering. This is the case with bursts, for instance. To obtain a well-triggered display in this case, the assistance of the variable holdoff function or the delayed timebase may be required. Television video signals are relatively easy to trigger using the built-in TV-Sync-Separator (TV).

For optional operation as a DC or AC voltage amplifier, each vertical amplifier input is provided with a DC/AC switch. DC coupling should only be used with a series-connected attenuator probe or at very low frequencies or if the measurement of the DC voltage content of the signal is absolutely necessary.

When displaying very low frequency pulses, the flat tops may be sloping with AC coupling of the vertical amplifier (AC limit frequency approx. 1.6 Hz for 3dB). In this case, DC operation is preferred, provided the signal voltage is not superimposed on a too high DC level. Otherwise a capacitor of adequate capacitance must be connected to the input of the vertical amplifier with DC coupling. This capacitor must have a sufficiently high breakdown voltage rating. DC coupling is also recommended for the display of logic and pulse signals, especially if the pulse duty factor changes constantly. Otherwise the display will move upwards or downwards at each change. Pure direct voltages can only be measured with DC-coupling.

The input coupling is selectable by the AC/DC pushbutton. The actual setting is displayed in the readout with the "DC" symbol for DC- and the "AC" symbol for AC coupling.

Amplitude Measurements

In general electrical engineering, alternating voltage data normally refers to effective values (rms = root-mean-square value). However, for signal magnitudes and voltage designations in oscilloscope measurements, the peak-to-peak voltage (V_{pp}) value is applied. The latter corresponds to the real potential difference between the most positive and most negative points of a signal waveform.

If a sinusoidal waveform, displayed on the oscilloscope screen, is to be converted into an effective (rms) value, the resulting peak-to-peak value must be divided by $2\sqrt{2} = 2.83$. Conversely, it should be observed that sinusoidal voltages indicated in V_{rms} (V_{eff}) have 2.83 times the potential difference in V_{pp} . The relationship between the different voltage magnitudes can be seen from the following figure.

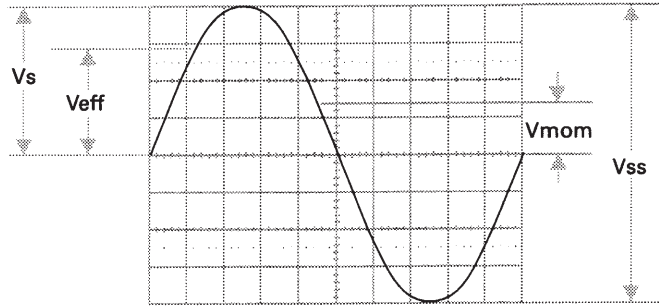

Voltage values of a sine curve

V_{rms} = effective value; V_p = simple peak or crest value; V_{pp} = peak-to-peak value; V_{mom} = momentary value.

The minimum signal voltage which must be applied to the Y input for a trace of 1div height is 1mVpp ($\pm 5\%$) when this deflection coefficient is displayed on the screen (readout) and the vernier is switched off (VAR-LED dark). However, smaller signals than this may also be displayed. The deflection coefficients are indicated in mV/div or V/div (peak-to-peak value).

The magnitude of the applied voltage is ascertained by multiplying the selected deflection coefficient by the vertical display height in div. If an attenuator probe x10 is used, a further multiplication by a factor of 10 is required to ascertain the correct voltage value.

For exact amplitude measurements, the variable control (**VAR**) must be set to its calibrated detent **CAL** position.

With the variable control activated the deflection sensitivity can be reduced up to a ratio of 2.5 to 1 (**please note „controls and readout“**). Therefore any intermediate value is possible within the 1-2-5 sequence of the attenuator(s).

With direct connection to the vertical input, signals up to 400Vpp may be displayed (attenuator set to 20V/div, variable control to 2.5:1).

With the designations

- H = display height in div,
- U = signal voltage in Vpp at the vertical input,
- D = deflection coefficient in V/div at attenuator switch,

the required value can be calculated from the two given quantities:

$$U = D \cdot H \quad H = \frac{U}{D} \quad D = \frac{U}{H}$$

However, these three values are not freely selectable. They have to be within the following limits (trigger threshold, accuracy of reading):

- H between 0.5 and 8div, if possible 3.2 to 8div,
- U between 1mVpp and 160Vpp,
- D between 1mV/div and 20V/div in 1-2-5 sequence.

Examples:
Set deflection coefficient $D = 50\text{mV/div}$ 0.05V/div ,
observed display height $H = 4.6\text{div}$,
required voltage $U = 0.05 \times 4.6 = 0.23\text{Vpp}$.

Input voltage $U = 5\text{Vpp}$,
set deflection coefficient $D = 1\text{V/div}$,
required display height $H = 5:1 = 5\text{div}$.

Signal voltage $U = 230\text{Vrms} \times 2\sqrt{2} = 651\text{Vpp}$
(voltage > 160Vpp, with probe 10:1: $U = 65.1\text{Vpp}$).

desired display height $H = \text{min. } 3.2\text{div, max. } 8\text{div,}$
 max. deflection coefficient $D = 65.1:3.2 = 20.3\text{V/div,}$
 min. deflection coefficient $D = 65.1:8 = 8.1\text{V/div,}$
 adjusted deflection coefficient $D = 10\text{V/div.}$

The previous examples are related to the CRT graticule reading. The results can also be determined with the aid of the DV cursor measurement (**please note „controls and readout“**).

The input voltage must not exceed 400V, independent from the polarity.

If an AC voltage which is superimposed on a DC voltage is applied, the maximum peak value of both voltages must not exceed + or -400V. So for AC voltages with a mean value of zero volt the maximum peak to peak value is 800V_{pp}.

If attenuator probes with higher limits are used, the probes limits are valid only if the oscilloscope is set to DC input coupling.

If DC voltages are applied under AC input coupling conditions the oscilloscope maximum input voltage value remains 400V. The attenuator consists of a resistor in the probe and the 1MΩ input resistor of the oscilloscope, which are disabled by the AC input coupling capacity when AC coupling is selected. This also applies to DC voltages with superimposed AC voltages. It also must be noted that due to the capacitive resistance of the AC input coupling capacitor, the attenuation ratio depends on the signal frequency. For sinewave signals with frequencies higher than 40Hz this influence is negligible.

With the above listed exceptions **HAMEG 10:1** probes can be used for DC measurements up to 600V or AC voltages (with a mean value of zero volt) of 1200V_{pp}. The 100:1 probe **HZ53** allows for 1200V DC or 2400V_{pp} for AC.

It should be noted that its AC peak value is derated at higher frequencies. If a normal x10 probe is used to measure high voltages there is the risk that the compensation trimmer bridging the attenuator series resistor will break down causing damage to the input of the oscilloscope. However, if for example only the residual ripple of a high voltage is to be displayed on the oscilloscope, a normal x10 probe is sufficient. In this case, an appropriate high voltage capacitor (approx. 22-68nF) must be connected in series with the input tip of the probe.

With **Y-POS.** control (input coupling to GD) it is possible to use a horizontal graticule line as reference line for ground potential before the measurement. It can lie below or above the horizontal central line according to whether positive and/or negative deviations from the ground potential are to be measured.

Total value of input voltage

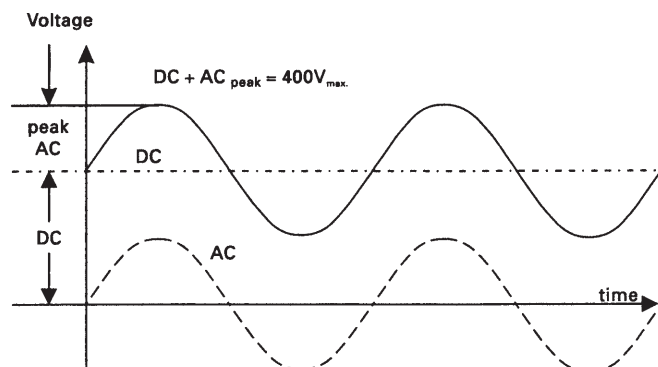

The dotted line shows a voltage alternating at zero volt level. If superimposed on a DC voltage, the addition of the positive peak and the DC voltage results in the max. voltage (DC + AC_{peak}).

Time Measurements

As a rule, most signals to be displayed are periodically repeating processes, also called periods. The number of periods per second is the repetition frequency. Depending on the timebase setting (**TIME/DIV.**-knob) indicated by the readout, one or several signal periods or only a part of a period can be displayed. The time coefficients are stated in ms/div, μs/div or ns/div. The following examples are related to the CRT graticule reading. The results can also be determined with the aid of the ΔT and 1/ΔT cursor measurement (**please note „controls and readout“**).

The duration of a signal period or a part of it is determined by multiplying the relevant time (horizontal distance in div) by the (calibrated) time coefficient displayed in the readout .

Uncalibrated, the timebase speed can be reduced until a maximum factor of 2.5 is reached. Therefore any intermediate value is possible within the 1-2-5 sequence.

With the designations

L = displayed wave length in div of one period,
 T = time in seconds for one period,
 F = recurrence frequency in Hz of the signal,
 Tc = time coefficient in ms, μs or ns/div and the relation $F = 1/T$, the following equations can be stated:

$$T = L \cdot Tc \quad L = \frac{T}{Tc} \quad Tc = \frac{T}{L}$$

$$F = \frac{1}{L \cdot Z} \quad L = \frac{1}{F \cdot Tc} \quad Tc = \frac{1}{L \cdot F}$$

However, these four values are not freely selectable. They have to be within the following limits:

L between 0.2 and 10div, if possible 4 to 10div,
 T between 10ns and 5s,
 F between 0.5Hz and 100MHz,
 Tc between 100ns/div and 500ms/div in 1-2-5 sequence (with X-MAG. (x10) inactive), and

Tc between 10ns/div and 50ms/div in 1-2-5 sequence (with X-MAG. (x10) active).

Examples:

Displayed wavelength $L = 7\text{div,}$
 set time coefficient $Tc = 100\text{ns/div,}$
 required period $T = 7 \times 100 \times 10^{-9} = 0.7\mu\text{s}$
 required rec. freq. $F = 1:(0.7 \times 10^{-6}) = 1.428\text{MHz.}$

Signal period $T = 1\text{s,}$
 set time coefficient $Tc = 0.2\text{s/div,}$
 required wavelength $L = 1:0.2 = 5\text{div.}$

Displayed ripple wavelength $L = 1\text{div,}$
 set time coefficient $Tc = 10\text{ms/div,}$
 required ripple freq. $F = 1:(1 \times 10 \times 10^{-3}) = 100\text{Hz.}$

TV-line frequency $F = 15625\text{Hz,}$
 set time coefficient $Tc = 10\mu\text{s/div,}$
 required wavelength $L = 1:(15.625 \times 10^{-5}) = 6.4\text{div.}$

Sine wavelength $L = \text{min. } 4\text{div, max. } 10\text{div,}$
 Frequency $F = 1\text{kHz,}$

Type of signal voltage

max. time coefficient $T_c = 1:(4 \times 10^3) = 0.25 \text{ms/div}$,
 min. time coefficient $T_c = 1:(10 \times 10^9) = 0.1 \text{ms/div}$,
 set time coefficient $T_c = 0.2 \text{ms/div}$,
 required wavelength $L = 1:(103 \times 0.2 \times 10^{-3}) = 5 \text{div}$.

Displayed wavelength $L = 0.8 \text{div}$,
 set time coefficient $T_c = 0.5 \mu\text{s/div}$,
 pressed X-MAG. (x10) button: $T_c = 0.05 \mu\text{s/div}$,
 required rec. freq. $F = 1:(0.8 \times 0.05 \times 10^{-6}) = 25 \text{MHz}$,
 required period $T = 1:(25 \times 10^6) = 40 \text{ns}$.

If the time is relatively short as compared with the complete signal period, an expanded time scale should always be applied (X-MAG. (x10) active). In this case, the time interval of interest can be shifted to the screen center using the X-POS. control.

When investigating pulse or square waveforms, the critical feature is the risetime of the voltage step. To ensure that transients, ramp-offs, and bandwidth limits do not unduly influence the measuring accuracy, the risetime is generally measured between 10% and 90% of the vertical pulse height. For measurement, adjust the Y deflection coefficient using its variable function (uncalibrated) together with the Y-POS. control so that the pulse height is precisely aligned with the 0% and 100% lines of the internal graticule. The 10% and 90% points of the signal will now coincide with the 10% and 90% graticule lines. The risetime is given by the product of the horizontal distance in div between these two coincident points and the calibrated time coefficient setting. The fall time of a pulse can also be measured by using this method.

The following figure shows correct positioning of the oscilloscope trace for accurate risetime measurement.

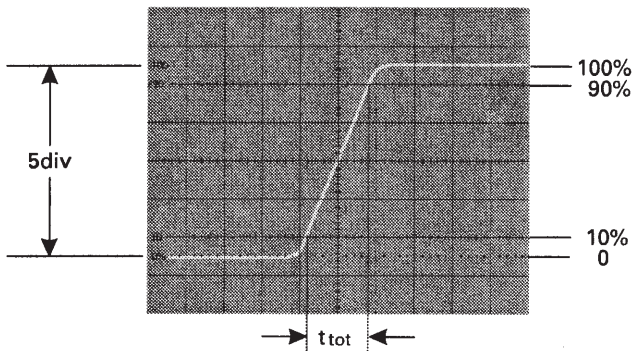

With a time coefficient of 10ns/div (X x10 magnification active), the example shown in the above figure results in a total measured risetime of

$$t_{\text{tot}} = 1.6 \text{div} \times 10 \text{ns/div} = 16 \text{ns}$$

When very fast risetimes are being measured, the risetimes of the oscilloscope amplifier and of the attenuator probe has to be deducted from the measured time value. The risetime of the signal can be calculated using the following formula.

$$t_r = \sqrt{t_{\text{tot}}^2 - t_{\text{osc}}^2 - t_p^2}$$

In this t_{tot} is the total measured risetime, t_{osc} is the risetime of the oscilloscope amplifier (approx. 8.75ns), and t_p the risetime of the probe (e.g. = 2ns). If t_{tot} is greater than 100ns, then t_{tot} can be taken as the risetime of the pulse, and calculation is unnecessary.

Calculation of the example in the figure above results in a signal risetime

$$\sqrt{16^2 - 8.75^2 - 2^2} = 13.25 \text{ns}$$

The measurement of the rise or fall time is not limited to the trace dimensions shown in the above diagram. It is only particularly simple in this way. In principle it is possible to measure in any display position and at any signal amplitude. It is only important that the full height of the signal edge of interest is visible in its full length at not too great steepness and that the horizontal distance at 10% and 90% of the amplitude is measured. If the edge shows rounding or overshooting, the 100% should not be related to the peak values but to the mean pulse heights. Breaks or peaks (glitches) next to the edge are also not taken into account. With very severe transient distortions, the rise and fall time measurement has little meaning. For amplifiers with approximately constant group delay (therefore good pulse transmission performance) the following numerical relationship between rise time t_r (in ns) and bandwidth B (in MHz) applies:

$$t_r = \frac{350}{B} \quad B = \frac{350}{t_r}$$

Connection of Test Signal

In most cases briefly depressing the **AUTO SET** causes a useful signal related instrument setting. The following explanations refer to special applications and/or signals, demanding a manual instrument setting. **The description of the controls is explained in the section „controls and readout“.**

Caution: When connecting unknown signals to the oscilloscope input, always use automatic triggering and set the input coupling switch to AC (readout). The attenuator should initially be set to 20V/div.

Sometimes the trace will disappear after an input signal has been applied. Then a higher deflection coefficient (lower input sensitivity) must be chosen until the vertical signal height is only 3-8div. With a signal amplitude greater than 160Vpp and the deflection coefficient (VOLTS/DIV.) in calibrated condition, an attenuator probe must be inserted before the vertical input. If, after applying the signal, the trace is nearly blanked, the period of the signal is probably substantially longer than the set time deflection coefficient (TIME/DIV.). It should be switched to an adequately larger time coefficient.

The signal to be displayed can be connected directly to the Y-input of the oscilloscope with a shielded test cable such as **HZ32** or **HZ34**, or reduced through a x10 or x100 attenuator probe. The use of test cables with high impedance circuits is only recommended for relatively low frequencies (up to approx. 50kHz). For higher frequencies, the signal source must be of low impedance, i.e. matched to the characteristic resistance of the cable (as a rule 50Ω). Especially when transmitting square and pulse signals, a resistor equal to the characteristic impedance of the cable must also be connected across the cable directly at the Y-input of the oscilloscope. When using a 50Ω cable such as the **HZ34**, a 50Ω through termination type **HZ22** is available from **HAMEG**. When transmitting square signals with short rise times, transient phenomena on the edges and top of the signal may become visible if the correct termination is not used. A terminating resistance is sometimes recommended with sine signals as well. Certain amplifiers, generators or their attenuators maintain the nominal output voltage independent of frequency only if their connection cable is terminated with the prescribed resistance. Here it must be noted that the terminating resistor **HZ22** will only dissipate a maximum of 2Watts. This power is reached with 10V_{rms} or at 28.3Vpp with sine signal. If a x10 or x100 attenuator probe is used, no termination is necessary. In this case, the connecting cable is matched directly to the high impedance input of the oscilloscope. When using attenuator probes, even high inter-

nal impedance sources are only slightly loaded (approx. $10\text{M}\Omega$ || 12pF or $100\text{M}\Omega$ || 5pF with **HZ53**). Therefore, if the voltage loss due to the attenuation of the probe can be compensated by a higher amplitude setting, the probe should always be used. The series impedance of the probe provides a certain amount of protection for the input of the vertical amplifier. Because of their separate manufacture, all attenuator probes are only partially compensated, therefore accurate compensation must be performed on the oscilloscope (see Probe compensation).

Standard attenuator probes on the oscilloscope normally reduce its bandwidth and increase the rise time. In all cases where the oscilloscope bandwidth must be fully utilized (e.g. for pulses with steep edges) we strongly advise using the probes **HZ51** (x10) **HZ52** (x10 HF) and **HZ54** (x1 and x10). This can save the purchase of an oscilloscope with larger bandwidth.

The probes mentioned have a HF-calibration in addition to low frequency calibration adjustment. Thus a group delay correction to the upper limit frequency of the oscilloscope is possible with the aid of a 1MHz calibrator, e.g. **HZ60**.

In fact the bandwidth and rise time of the oscilloscope are not noticeably changed with these probe types and the waveform reproduction fidelity can even be improved because the probe can be matched to the oscilloscopes individual pulse response.

If a x10 or x100 attenuator probe is used, DC input coupling must always be used at voltages above 400V. With AC coupling of low frequency signals, the attenuation is no longer independent of frequency, pulses can show pulse tilts. Direct voltages are suppressed but load the oscilloscope input coupling capacitor concerned. Its voltage rating is max. 400 V (DC + peak AC). DC input coupling is therefore of quite special importance with a x100 attenuation probe which usually has a voltage rating of max. 1200 V (DC + peak AC). A capacitor of corresponding capacitance and voltage rating may be connected in series with the attenuator probe input for blocking DC voltage (e.g. for hum voltage measurement).

With all attenuator probes, the maximum AC input voltage must be derated with frequency usually above 20kHz. Therefore the derating curve of the attenuator probe type concerned must be taken into account.

The selection of the ground point on the test object is important when displaying small signal voltages. It should always be as close as possible to the measuring point. If this is not done, serious signal distortion may result from spurious currents through the ground leads or chassis parts. The ground leads on attenuator probes are also particularly critical. They should be as short and thick as possible. When the attenuator probe is connected to a BNC-socket, a BNC-adaptor, should be used. In this way ground and matching problems are eliminated. Hum or interference appearing in the measuring circuit (especially when a small deflection coefficient is used) is possibly caused by multiple grounding because equalizing currents can flow in the shielding of the test cables (voltage drop between the protective conductor connections, caused by external equipment connected to the mains/line, e.g. signal generators with interference protection capacitors).

Controls and Readout

The following description assumes that the operating mode „COMPONENT TEST“ is switched off.

All important measuring parameter settings are displayed in the screen Readout when the oscilloscope is on.

The LED indicators on the large front panel facilitate operation and provide additional information. Electrical end positions of controls are indicated by acoustic signal (beep).

All controls, except the power switch (**POWER**), the calibration frequency pushbutton (**CAL. 1kHz/1MHz**), the **FOCUS** control and the trace rotation control, are electronically set and inter-rogated. Thus, all electronically set functions and their current settings can be stored and also remotely controlled.

The large front panel is, as is usual with Hameg oscilloscopes, is marked with several fields.

The following controls and LED indicators are located on the top, to the right of the screen, above the horizontal line:

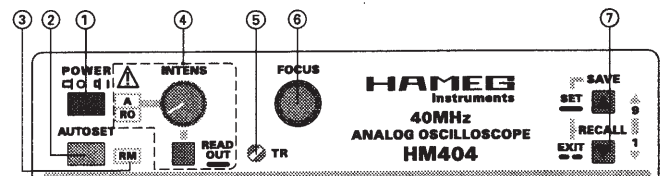

- (1) POWER**
Pushbutton and symbols for **ON (I)** and **OFF (O)**.

After the oscilloscope is switched on, all LEDs are lit and an automated instrument test is performed. During this time the **HAMEG** logo and the software version are displayed on the screen. After the internal test is completed successfully, the overlay is switched off and the normal operation mode is present. Then the last used settings become activated and one LED indicates the ON condition.

Some mode functions can be modified (**SETUP**) and/or automated adjustment procedures (**CALIBRATE**) can be called if the „**MAIN MENU**“ is present. **For further information please note „MENU“.**

- (2) AUTO SET**
Briefly depressing this pushbutton results in an automatic instrument setting automatically selecting Yt mode. The instrument is set to the last used Yt mode setting (**CH I, CH II** or **DUAL**). **SEARCH (SEA)** and **DELAY (DEL and DTR)** mode is automatically switched off. **Please note „AUTO SET“.**

- (3) RM**
The remote control mode can be switched on or off („**RM**“ LED dark) via the **RS232** interface. On condition that the „**RM**“ LED is lit, all electronically selectable controls on front panel are inactive. This state can be left by depressing the **AUTO SET** pushbutton provided it was not deactivated via the interface.

- (4) INTENS - READOUT -**
Knob with associated pushbutton and LEDs.

This control knob is for adjusting the A trace and readout intensity. Turning this knob clockwise increases and turning it counterclockwise decreases the intensity.

The **READOUT** pushbutton below is for selecting the function in two ways.

Controls and Readout

If the readout (**RO**) is not switched off, briefly pressing the **READOUT** pushbutton switches over the **INTENS** knob function indicated by a LED in the sequence:

Yt (timebase) mode: A - RO - A
 XY mode: A - RO - A.
 Component Test: A - RO - A.

Pressing and holding the **READOUT** pushbutton switches the readout on or off. In readout off condition the **INTENS** knob function can consequently not be set to **RO**.

Switching the readout off, may be required if interference is visible on the signal(s). Such interference may also originate from the chopper generator if the instrument is operated in chopped **DUAL** mode.

With the exception of the letters „**CT**“ all other **READOUT** information is switched off in **COMPONENT TEST** mode.

All **INTENS** settings are stored after the instrument is switched off.

The **AUTOSET** function switches the readout on. The **INTENS** setting for each function is automatically set to the mean value, if less intensity was previously selected.

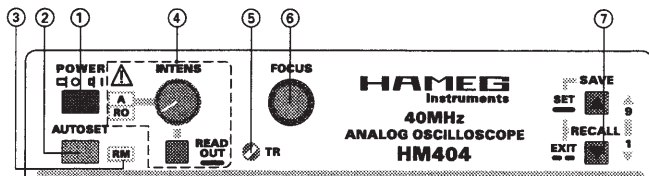

(5) TR

The trace rotation control can be adjusted with a small screwdriver (*please note „trace rotation TR“*)

(6) FOCUS

This control knob effects both the trace and the readout sharpness.

(7) SAVE / RECALL

The instrument contains 9 non volatile memories. These can be used by the operator to save instrument settings and to recall them. This relates to all controls which are electronically selected.

SAVE:

Press the **SAVE** pushbutton briefly to start the save procedure. The readout then indicates the letter „**S**“ followed by a cipher between **1** and **9**, indicating the memory location. If the instrument settings stored in this memory location must not be overwritten, briefly press the **SAVE** or the **RECALL** pushbutton to select another memory location. Each time the **SAVE** pushbutton is briefly pressed the memory location cipher increases until the location number 9 is reached. The **RECALL** pushbutton function is similar but decreases the memory location cipher until 1 is reached. Press and hold **SAVE** for approx. 3 seconds to write the instruments settings in the memory.

RECALL:

To recall a front panel setup, start that procedure by briefly pressing the **RECALL** pushbutton. The readout then indicates the letter „**R**“ and the memory location number. If required, select a different memory location as described above. Recall the settings by pressing and holding the **RECALL** pushbutton for approx. 3 seconds.

Attention:

Make sure that the signal to be displayed is similar to the one that was present when the settings were stored. If the signal is different (frequency, amplitude) to the one during storage then a distorted display may result.

If the **SAVE** or the **RECALL** pushbutton was depressed inadvertently, briefly press both pushbuttons at the same time or wait approx. 10 seconds without pressing either pushbutton to exit that function.

The setting controls and LED's for the Y amplifiers, modes, triggering and timebase are located underneath the sector of the front panel described before.

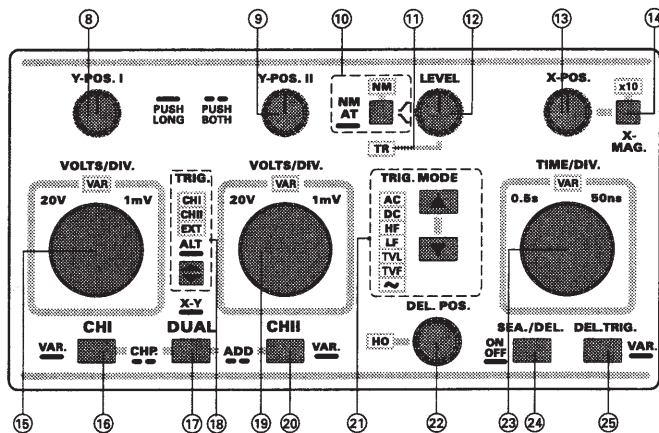

(8) Y-POS. I - Control knob.

The **vertical trace position** of channel I can be set with this control knob. In **ADD** (addition) mode both (**Y-POS. I** and **Y-POS. II**) control knobs are active.

(9) Y-POS. II - Control knob.

The **vertical trace position** of channel II can be set with this control knob. In **ADD** (addition) mode both (**Y-POS. I** and **Y-POS. II**) control knobs are active. If the instrument is set to **XY** mode this control knob is **inactive** and the **X-POS.** knob must be used for a horizontal position shift.

(10) NM - AT - $\int \setminus$

Pushbutton with a double function and associated **NM-LED**.

NM - AT selection:

Press and hold the pushbutton to switch over from automatic (peak value) to normal triggering (**NM-LED** above the pushbutton lit) and vice versa. If the LED is dark, automatic (peak value) triggering is selected.

Whether the peak value detection in automatic trigger mode is automatically activated or not, depends on the trigger coupling setting (**TRIG.MODE**). The way the trigger point symbol in the readout responds on different **LEVEL** control knob settings indicates the situation:

1. If the trigger symbol can not be shifted in the vertical direction when a signal is not applied or the signal height is not sufficient, the peak value detection is active.
2. Under the condition that the trigger point symbol cannot be shifted in such a way that it leaves the signal display on the screen, the peak value detection is active.
3. The peak value detection is switched off if the trigger point can be set outside the maximum peak values of the signal, thus causing an untriggered signal display.

Slope selection:

Briefly pressing this pushbutton selects which slope of the signal is used for triggering the timebase generator.

Each time this pushbutton is briefly pressed, the slope direction switches from falling edge to rising edge and vice versa.

The current setting is displayed in the readout by a slope symbol. The last setting in undelayed timebase mode is stored and still active if triggered **DELAY (DTR)** timebase mode is selected. This allows for a different slope setting for the triggered **DELAY (DTR)** timebase mode.

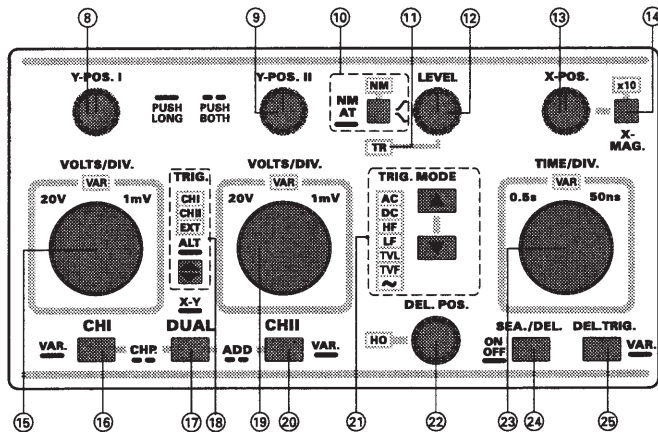

(11) TR - Trigger indicator LED.

The **TR** LED is lit in **Yt** mode if the triggering conditions are met. Whether the LED flashes or is lit constantly depends on the frequency of the trigger signal.

(12) LEVEL - Control knob.

Turning the **LEVEL** knob causes a different trigger point setting (voltage). The trigger unit starts the timebase when the edge of a trigger signal crosses the trigger point. In most **Yt** modes the trigger point is displayed in the readout by the symbol on the left vertical graticule line. If the trigger point symbol would overwrite other readout information or would be invisible when being set above or below the screen, the symbol changes and an arrow indicates in which vertical direction the trigger point has left the screen.

The trigger point symbol is automatically switched off in those modes where there is no direct relation between the trigger signal and the displayed signal. The last setting in undelayed timebase mode is stored and still active if triggered **DELAY (DTR)** timebase mode is selected.

This allows for a different level setting for the triggered **DELAY (DTR)** timebase mode.

(13) X-POS. - Control knob.

This control knob enables an X position shift of the signal(s) in **Yt** and **XY** mode. In combination with X magnification x10 (**Yt** mode) this function makes it possible to shift any part of the signal on the screen.

(14) X-MAG. x10 - Pushbutton and LED.

Each time this pushbutton is pressed the **x10** LED located above is switched on or off. If the **x10** LED is lit, the signal display in all **Yt** (timebase) modes is expanded 10 fold and consequently only a tenth part of the signal curve is

visible. The interesting part of the signal can be made visible with aid of the **X-POS. (13)** control. As the X expansion results in a higher timebase speed (lower time deflection coefficient), all time and frequency relevant information in the readout is switched over.

Please note!

The expansion is 5 fold if the timebase is set to 50ns/div. Consequently the lowest time deflection coefficient is 10ns/div.

This pushbutton is not operative in XY mode.

(15) VOLTS/DIV.

This control knob for channel I has a double function.

The following description relates to the **input attenuator function (VAR-LED dark)**.

Turning the control knob clockwise increases the sensitivity (decreases the deflection coefficient) in a 1-2-5 sequence and decreases the sensitivity (increases the deflection coefficient) if turned in the opposite direction (ccw.). The available range is from 1mV/div up to 20V/div. The knob is automatically switched inactive if the channel related to it is switched off, or if the input coupling is set to **GD** (ground).

The deflection coefficients and additional information regarding the active channel(s) are displayed in the readout, i.e. **„Y1: deflection coefficient, input coupling“**. The **„<“** symbolizes calibrated measuring conditions and is replaced by the **„>“** symbol in uncalibrated conditions.

(16) CH I - VAR. - Pushbutton with several functions.

CH I mode:

Briefly pressing the **CHI** button sets the instrument to channel I (**Mono CH I**) mode. The deflection coefficient displayed in the readout indicates the current conditions (**„Y1...“**). If neither external nor line (mains) triggering was active, the internal trigger source automatically switches over to **channel I (TRIG.-LED (18) CHI** lits). The last function setting of the **VOLTS/DIV (15)** knob remains unchanged.

All channel I related controls are active if the **input (26)** is not set to **GD (28)**.

VAR.:

Pressing and holding this pushbutton selects the **VOLTS/DIV. (15)** control knob function between attenuator and vernier (variable). The current setting is displayed by the **VAR-LED** located above the knob.

After switching the **VAR-LED (15)** on, the deflection coefficient is still calibrated. Turning the **VOLTS/DIV. (15)** control knob counter clockwise reduces the signal height and the deflection coefficient becomes uncalibrated.

The readout then displays i.e. **„Y1>...“** indicating the uncalibrated condition instead of **„Y1...“**. Pressing and holding the **CHI** pushbutton again switches the LED off, sets the deflection coefficient into calibrated condition and activates the attenuator function. The previous vernier setting will not be stored.

The **CHI** pushbutton can also be pressed simultaneously with the **DUAL(17)** button.

Please note item (17).

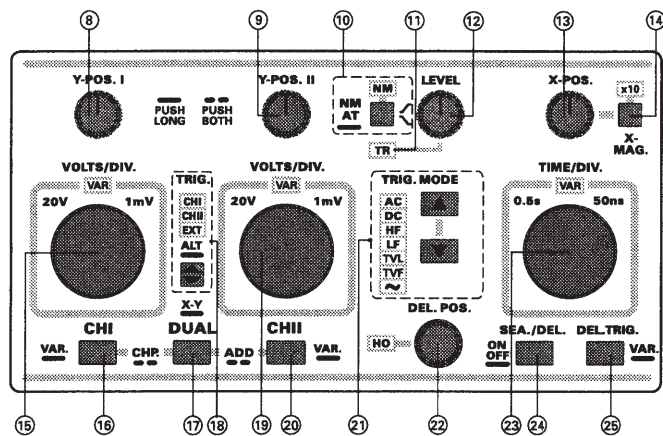

(17) DUAL - XY - Pushbutton with multiple functions.

DUAL mode:

Briefly pressing this button switches over to **DUAL** mode. Both deflection coefficients are then displayed. The previous trigger setting stays as it was, but can be changed.

All controls related to both channels are active, if the **inputs (26)** and **(30)** are not set to **GD (28) (32)**.

Whether alternated or chopped channel switching is present depends on the actual timebase setting, and is displayed in the readout.

ALT:

displayed in the readout, indicates alternate channel switching. After each timebase sweep the instrument internally switches over from channel I to channel II and vice versa. This channel switching mode is automatically selected if any time coefficient from 200 μ s/div to 50ns/div is active.

CHP:

indicates chopper mode, whereby the channel switching occurs constantly between channel I and II during each sweep. This channel switching mode occurs when any timebase setting between 500ms/div and 500 μ s/div has been chosen.

The actual channel switching can be changed to the opposite mode by briefly pressing both **CHI (16)** and **DUAL (17)** simultaneously. If afterwards the time coefficient is changed, the channel switching is automatically set to the time coefficient related mode.

ADD mode:

Addition mode can be selected by briefly pressing the **DUAL (17)** and **CHII (20)** buttons **simultaneously**. Whether the algebraic sum (addition) or the difference (subtraction) of both input signals is displayed, depends on the phase relationship and the **INV (32)** setting. As a result both signals are displayed as one signal. For correct measurements the deflection coefficients for both channels must be equal.

Please note „Operating modes of the vertical amplifiers in Yt mode“.

The readout indicates this mode by a „+“ sign located between both channel deflection coefficients. While the trigger mode is not affected, the trigger point symbol is switched off.

The Y-position of the signal can be influenced by both **Y-POS** controls **(8)** and **(9)**.

XY mode:

This mode can be switched on or off by **pressing and holding** the **DUAL (17)**.

In **XY** mode the deflection coefficients are displayed as „Y...“ for channel I and „X...“ for channel II, followed by „XY“. Except the cursor lines which may be active, all other readout information including the trigger point symbol are switched off. In addition to all trigger and timebase related controls, the **Y-POS. II (9)** knob and **INV (32)** button are deactivated. For X position alteration, the **X-POS. (13)** knob can be used.

(18) TRIG.

Pushbutton with double function for trigger source selection and associated LEDs.

The button and the LEDs are deactivated if line (mains) triggering is selected or XY operation is chosen.

With the aid of this button, the trigger source can be chosen. There are three trigger sources available: **channel I, channel II** (both designated as internal trigger sources) and the **TRIG. EXT. (33)** input for external triggering.

The availability of the internal sources depends on the actual channel mode. The actual setting is indicated by the associated LED(s).

Briefly pressing the button switches over in the following sequence:

- I - II - EXT - I** in **DUAL** and **ADD** (addition) mode,
- I - EXT - I** if **mono channel I** is present,
- II - EXT - II** under **mono channel II** conditions.

Each condition is indicated by the associated LED. The trigger point symbol is switched off in external trigger condition.

ALT:

Pressing and holding the button selects **alternate triggering** in **DUAL** mode. Under these conditions both I and II LEDs are lit. As alternate triggering requires alternate channel operation, alternate channel switching is set automatically. A change of the time coefficient then has no affect regarding the channel switching mode. In addition to the deflection coefficients display, „ALT“ is displayed by the readout instead of „CHP“.

In alternate trigger mode the trigger point symbol is switched off.

Alternate triggering is not available or automatically switched off under the following conditions:

- ADD** (addition) mode,
- search (**SEA**),
- delayed (**DEL** and **DTR**) timebase mode,
- TVL, TVF** and **line** (mains) trigger coupling.

(19) VOLTS/DIV. -

This control knob for channel II has a double function.

The following description relates to the input attenuator function (**VAR** LED dark).

Turning the control knob clockwise increases the sensitivity (decreases the deflection coefficient) in a 1-2-5 sequence and decreases the sensitivity (increases the deflection coefficient) if turned in the opposite direction

(ccw.). The available range is from 1mV/div up to 20V/div. The knob is automatically switched inactive if the channel related to it is switched off, or if the input coupling is set to GD (ground).

The deflection coefficients and additional information regarding the active channels are displayed in the readout, i.e. „Y2: deflection coefficient, input coupling“. The „:“ symbolizes calibrated measuring conditions and is replaced by the „>“ symbol in uncalibrated conditions.

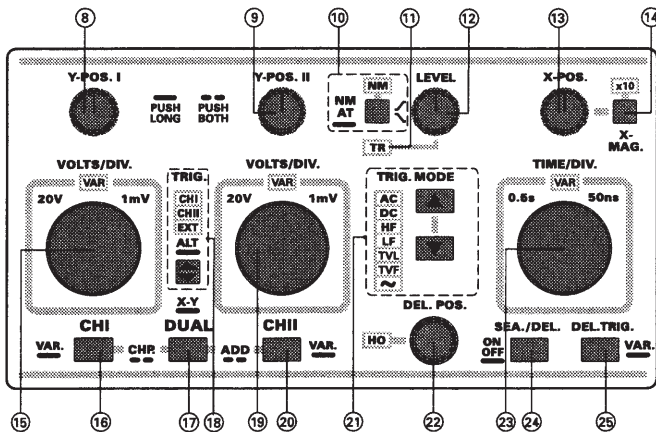

(20) CH II - VAR. - Pushbutton with several functions.

CH II mode:

Briefly pressing the button sets the instrument to **channel II (Mono CH II)** mode. The deflection coefficient displayed in the readout indicates the current conditions („Y2...“). If neither external nor line (mains) triggering was active, the internal trigger source automatically switches over to **channel II (TRIG.-LED (18) CHII** lights). The last function setting of the **VOLTS/DIV (19)** knob remains unchanged.

All channel related controls are active if the **input (30)** is not set to **GD (32)**.

VAR.:

Pressing and holding this pushbutton selects the **VOLTS/DIV. (19)** control knob function between attenuator and vernier (variable). The current setting is displayed by the **VAR-LED** located above the knob.

After switching the **VAR-LED (19) on**, the deflection coefficient is still calibrated. Turning the **VOLTS/DIV. (19)** control knob counter clockwise reduces the signal height and the deflection coefficient becomes uncalibrated.

The readout then displays „Y2>...“ indicating the uncalibrated condition instead of „Y2:...“. Pressing and holding the CHII pushbutton again switches the LED off, sets the deflection coefficient into calibrated condition and activates the attenuator function. The previous vernier setting will not be stored.

The **CHII** pushbutton can also be pressed simultaneously with the **DUAL (17)** button. **Please note item (17)**.

(21) TRIG. MODE - Pushbuttons and indicator LEDs.

Pressing the upper or lower button selects the trigger coupling. The actual setting is indicated by a **TRIG.-LED (18)**.

Each time the lower TRIG. MODE pushbutton is pressed the trigger coupling changes in the sequence:

- AC** DC content suppressed,
- DC** peak value detection inactive,
- HF** high-pass filter cuts off frequencies below approx. 50kHz, trigger point symbol switched off
- LF** low-pass filter cuts off frequencies above approx. 1.5kHz,
- TVL** TV signal, line pulse triggering, trigger point symbol switched off,
- TVF** TV signal, frame pulse triggering, trigger point symbol switched off.
- ~** line/mains triggering, trigger point symbol and **TRIG. LED (18)** are switched off.

In some trigger modes such as alternate triggering, some trigger coupling modes are automatically disabled and can not be selected.

(22) DEL.POS. - HO

rotary knob with two functions and related **HO** LED.

The **DEL.POS.** rotary knob functions as a Hold off time control, when the time base is not working in the **SEA. (SEARCH)** or in **DEL. (DELAY)** mode.

The **HO-LED** is not lit when the hold off time is set to minimum. The **HO** LED lights up and the hold off time increases as the knob is rotated clockwise. A signal sounds on reaching the maximum hold off time. Similarly in the opposite direction until minimum hold off time is reached (**HO** LED extinguishes).

The hold off time is automatically set to minimum when the time base is changed. (For the application of hold off time setting see the paragraph with the same heading).

A delay time between the trigger event and the start of the trace can be set with the **DEL.POS.** control in the time base modes **SEA. (SEARCH)** or **DEL. (DELAY)**. **See SEA./DEL.-ON/OFF (24)**.

(23) TIME/DIV.

The time base is set with this rotary knob in the **TIME/DIV.** field, and the setting is displayed at the top left in the Readout (e.g. "T:10µs").

This knob acts as the time base switch when the **VAR** LED above it is not lit. Then, the time deflection coefficient can be set in a 1-2-5 sequence and the time base is calibrated. Rotating anticlockwise increases the deflection coefficient and rotating clockwise decreases the deflection. The control acts as a vernier (fine adjustment) when the **VAR** LED is lit.

The following description refers to the function as a time base switch.

Time deflection coefficients between 500ms/div. and 50ns/div. in a 1-2-5 sequence can be selected without x10 X magnification.

Time delay between 100ms and 100ns can be selected in the **"SEA" (SEARCH)** mode.

Time deflection coefficient range in the **"DEL" (DELAY)** mode extends from 20ms/div. to 50ns/div.

(24) SEA./DEL. - ON/OFF pushbutton.

This button is used to switch between delayed and undelayed time base. The delayed time base operation enables a magnified display in X direction which is otherwise only possible with a second time base.

Controls and Readout

Pressing and holding the button switches to **SEA. (SEARCH)** mode, when currently neither **"SEA" (SEARCH)** nor **"DEL" (DELAY)** operation is effective. Afterwards, it can be switched between **SEA.** and **DEL.** by briefly pressing the button.

These operating modes are indicated in the Readout at the right of the trigger slope indication thus:

In case of **SEARCH**, **"SEA"** will be displayed; In untriggered **DELAY** mode, **"DEL" (DEL.)** and in triggered **DELAY** mode, **"DTR" (DEL.TRIG.)**.

None of these will appear in the Readout in undelayed time base operation.

When **"SEA"**, **"DEL"** or **"DTR"** mode is effective, pressing and holding the button switches over to undelayed time base.

The following description assumes that, with **x10 X-MAG.** switched off, the trace starts at left edge of the graticule.

In **SEA. (SEARCH)** mode, the hold off time is automatically set to minimum and for the first few divisions the trace is blanked. The trace will then be unblanked. The point at which the trace starts can be varied with **DEL.POS** (fine adjustment) from about 2 to 7 divisions. The blanked section serves as a guide to the delay time. The delay time is based on the current time deflection coefficient setting and can also be coarsely set with the **TIME/DIV** control (range: 20ms to 100ns).

Pressing the button briefly switches over from **"SEA"** to **DEL" (DELAY)** mode. Now the trace starts at the left edge without blanking. The start of the section, which was previously unblanked in the **"SEA" (SEARCH)** mode, now lies at the left edge. The display can be expanded in the X direction by rotating the **TIME/DIV** control clockwise and thus decreasing the time deflection coefficient. If a part of the signal of interest goes beyond the right edge, it can be brought within the screen and made visible by **DEL.POS** knob. Increasing the time deflection coefficient beyond that used in the **"SEA" (SEARCH)** mode is not provided as it is practically meaningless.

In the untriggered **"DEL" (DELAY)** mode, a trigger event does not start the trace at once but only starts the delay time. After the delay time has elapsed the trace is started.

In triggered **DELAY** mode (**DTR**), to start the sweep, a signal suitable for triggering must appear after the delay time. The trace will be started if the instrument settings (e.g. **LEVEL** setting) enable a triggering. **See DEL.TRIG. (31).**

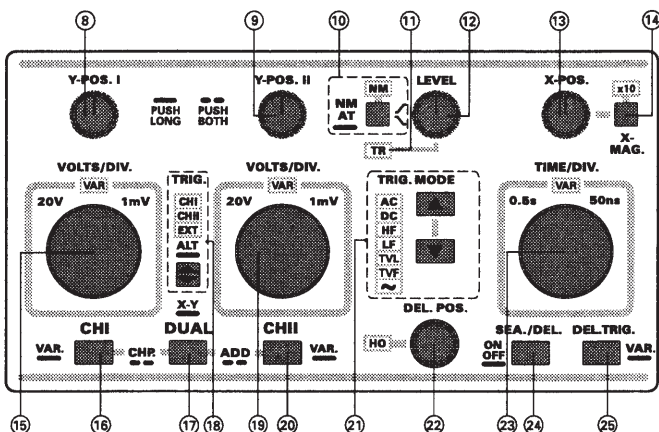

(25) DEL.TRIG. - VAR. -pushbutton with two functions.

In the case of untriggered **"DEL" (DELAY)** mode, **briefly pressing** the button switches over to **"DTR"** (triggered **DELAY** mode). Thereby, the previously active settings, **Automatic/normal triggering (10)**, trigger **LEVEL (12)**, trigger **slope (10)** and trigger **coupling (21)** will be stored.

It will be automatically switched to normal triggering and **DC** trigger coupling in **"DTR"** mode. Subsequently the trigger **LEVEL** setting and the trigger slope should be so adjusted that the signal for delayed trigger can trigger the timebase. Without triggering the screen will remain blank.

Briefly pressing the button again switches back to (untriggered) **DEL.** Operation.

Pressing and holding the button changes the function of the **TIME/DIV.** knob.

The **TIME/DIV.** knob can function as a time deflection coefficient switch (1-2-5 sequence) or as a time vernier (fine adjustment). The current function is indicated by the **VAR-LED**. The **TIME/DIV.** knob functions as a vernier when the **VAR-LED** is switched on, but the timebase setting remains calibrated until the (vernier) knob is operated. The readout now indicates **"T>..."** instead of **"T:..."**. Rotating further anticlockwise increases the time deflection coefficient (uncalibrated) until the maximum is reached indicated by a beep. Rotating the knob clockwise has the opposite effect. Now, the vernier is again in the calibrated position and the symbol **">"** will be replaced by symbol **":"**.

The function of the knob can be switched back to normal (calibrated) timebase, pressing and holding the button.

Underneath the front panel sector described above, the BNC sockets and four pushbuttons are located.

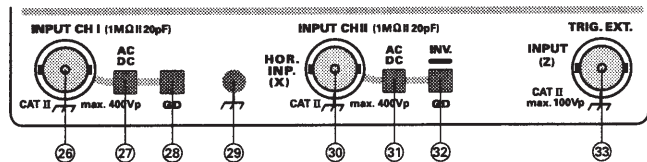

(26) INPUT CH I - BNC socket.

This BNC socket is the signal input for channel I. In **XY** mode, signals at this input are used for the Y deflection. The outer (ground) connection is galvanically connected to the instrument ground and consequently to the safety earth contact of the line/mains plug.

(27) AC / DC - Pushbutton with two functions.

Input coupling:

Briefly pressing this pushbutton switches over from **AC** (~ symbol) to **DC** (= symbol) input coupling and vice versa. The setting is displayed in the readout with the deflection coefficient.

Probe factor:

Pressing and holding the pushbutton selects the indicated deflection coefficient of channel I displayed in the readout, between 1:1 and 10:1. In condition 10:1 the probe factor is thus indicated by a probe symbol displayed by the readout in front the channel information (e.g. **"probe symbol", Y1...**). In the case of cursor voltage measurement, the probe factor is automatically included.

Please note:

The symbol must not be activated unless a x10 (10:1) attenuator probes are used.

(28) GD - Pushbutton.

Each time this pushbutton is pressed briefly, the input is switched from active to inactive and vice versa. It is displayed in the readout as an earth (ground) symbol instead of the deflection coefficient and the \sim (AC) or = (DC) symbol.

The **GD** setting disables the input signal, the **AC/DC (27)** pushbutton and the **VOLTS/DIV (15)** knob. In automatic trigger mode the undeflected trace is visible representing the 0 Volt trace position.

(29) Ground socket - 4mm banana socket galvanically connected to safety earth.

This socket can be used as reference potential connection for **DC** and low frequency signal measurement purposes and in **COMPONENT TEST** mode.

(30) INPUT CH II - BNC socket.

This **BNC** socket is the signal input for channel II. In XY mode, signals at this input are used for the X deflection. The outer (ground) connection is galvanically connected to the instrument ground and consequently to the safety earth contact of the line/mains plug.

(31) AC / DC - Pushbutton with two functions.

Input coupling:

Briefly pressing this pushbutton switches over from **AC** (\sim symbol) to **DC** (= symbol) input coupling and vice versa. The setting is displayed in the readout with the deflection coefficient.

Probe factor:

Pressing and holding the pushbutton selects the indicated deflection coefficient of channel II displayed in the readout, between 1:1 and 10:1. In condition 10:1 the probe factor is thus indicated by a probe symbol displayed by the readout in front the channel information (e.g. „probe symbol“, Y2...). In the case of cursor voltage measurement, the probe factor is automatically included.

Please note: The symbol must not be activated unless a x10 (10:1) attenuator probes are used.

(32) GD - INV. - Pushbutton with two functions.

GD:

Each time this pushbutton is pressed briefly, the input is switched from active to inactive and vice versa. It is displayed in the readout as an earth (ground) symbol instead of the deflection coefficient and the \sim (AC) or = (DC) symbol.

The **GD** setting disables the input signal, the **AC/DC (31)** pushbutton and the **VOLTS/DIV (20)** knob. In automatic trigger mode the undeflected trace is visible representing the 0 Volt trace position.

INV.:

Pressing and holding this pushbutton switches the channel II invert function on or off. The invert „on“ condition is indicated by the readout with a horizontal bar above „Y2“ (Yt mode). The invert function causes the signal display of channel II to be inverted by 180°.

In XY mode the invert function of channel II is automatically switched off.

(33) TRIG. EXT. / INPUT (Z) - BNC socket with two functions. The outer (ground) connection is galvanically connected to the instrument ground and consequently to the safety earth contact of the line/mains plug. The input impedance is approx. $1M\Omega$ || 20pF.

TRIG. EXT:

This **BNC** socket is the external trigger signal input, if external triggering is selected. Briefly pressing the **TRIG. (18)** pushbutton, until the **TRIG. „EXT“ -LED (18)** is lit, switches the external trigger input active.

The trigger coupling depends on the **TRIG. MODE (21)** setting.

Z- Input:

If neither **COMPONENT TEST** nor external trigger coupling (**TRIG. EXT.**) is chosen, the socket is operative as a **Z** (trace intensity modulation) input.

High TTL level (positive logic) effects blanking, low level gives unblanking. No higher voltages than +5 Volt are permitted.

Below the CRT there are the controls for the readout, the component tester and the squarewave calibrator with their outputs.

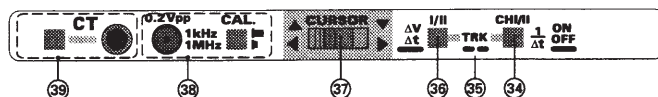

Please note:

The following description of the cursor related controls assumes that the readout is visible and the component tester is switched off.

(34) ON/OFF - CHI/II - 1/Δt

This pushbutton has several functions.

ON/OFF:

Pressing and holding the pushbutton switches both cursor lines on or off. As the cursor lines are part of the readout, they are visible only if the readout is switched on.

CHI/II:

This function is required and available only in **DUAL** and **XY** mode in combination with **ΔV (36)** measurement. The probe factor setting **(27) (31)** is automatically taken into account.

Briefly pressing the button selects between the deflection coefficients of channel I and channel II. The measured result is displayed by the readout with „ΔV1...“ or „ΔV2...“. The settings of the cursors must relate to the signal of the selected channel.

In **XY** mode the instrument is automatically set to **ΔV** measurement. In this mode two signals are normally applied causing an X and a Y deflection. The deflection coefficient selected for each channel may be different, thus as in **DUAL** mode the **ΔV** cursor measurement requires a channel selection. Under channel I (Y signal) measuring condition the cursor lines are displayed as horizontal lines and the readout displays „ΔVY...“. Briefly pressing the pushbutton changes to channel II (X signal) voltage measurement. Then the cursor lines are displayed as vertical lines and the readout indicates „ΔVX...“.

Controls and Readout

In **CH I** or **CH II** mono mode, only one deflection coefficient is present and there is no requirement to select between different deflection coefficients. Consequently the pushbutton is inactivated in combination with ΔV measurements.

1/ Δt :

Briefly pressing the button selects between time and frequency measurement, if the ΔV function is not present.

In calibrated timebase condition the readout displays „ Δt ...” if time measurement is chosen. After briefly pressing the pushbutton „f...” (frequency) is displayed. If the timebase is uncalibrated the readout displays „ Δt >...” or „f<...”.

Attention:

Time and frequency measurements are not possible in XY operation, since in this mode the timebase is switched off.

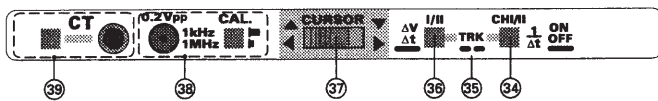

(35) TRK - CURSOR-Track function.

Briefly pressing simultaneously both buttons **ON/OFF - CHI/II - 1/ Δt (34)** and **I/II - $\Delta V/\Delta t$ (36)** switches over from single cursor line operation to track mode and vice versa.

In **TRK** (track) mode both cursor lines are indicated as active (both dotted lines uninterrupted).

(36) I/II - $\Delta V / \Delta t$ - Pushbutton with two functions.

I/II:

Briefly pressing this button changes the active (controllable) cursor in the sequence **I - II - I**, if **TRK** (track) mode is not active. The active cursor is indicated by a continuously dotted line. An interrupted dotted line indicates the inactive cursor.

$\Delta V / \Delta t$:

Pressing and holding this pushbutton changes from voltage to time (or frequency) measurement and vice versa. In **XY** mode the instrument is automatically set to ΔV .

ΔV :

Please note!

In all DV (voltage) measurement conditions, the division ratio of the probe(s) must be taken into account. The voltage value displayed in the readout must be multiplied by 100 if e.g. a x100 (100:1) probe is used. In case of x10 (10:1) probes, the probe factor can be automatically included (see item (27) and (31)).

item 1: Timebase mode (**CH I** or **CH II** single channel mode, **DUAL** and **ADD**).

In the voltage measurement condition, the cursors are displayed as horizontal lines and the result is displayed in the readout.

Single channel mode (channel I or channel II).

The ΔV measuring result is automatically related to the deflection coefficient of the active channel. The readout displays „ $\Delta V1$...” or „ $\Delta V2$...”.

Dual mode.

The **CURSOR** lines must be set on the channel I or

channel II signal. As the deflection coefficients may be different, it will be required to select between the deflection coefficients of channel I and II. Please note item **CHI/II (34)**.

Addition (ADD) mode.

In **ADD** (addition) mode normally two input signals are displayed as one signal (sum or difference). As the result can only be determined if both (calibrated) deflection coefficients are equal, the **CHI/II (34)** selection function is deactivated. In that case the readout indicates „ ΔV ...” without any additional channel information. Different deflection coefficient settings or uncalibrated deflection coefficient(s) are indicated in the readout as „**Y1<>Y2**”.

item 2: XY mode.

In **XY** mode the instrument is automatically set to ΔV measurement. The deflection coefficient selected for each channel may be different, thus as in **DUAL** mode the ΔV cursor measurement requires a channel selection. Under channel I (Y signal) measuring condition the cursor lines are displayed as horizontal lines and the readout displays „ ΔVY ...”. Briefly pressing the **CHI/II (34)** pushbutton selects **channel II** (X signal) measuring. Then the cursor lines are displayed as vertical lines and the readout indicates „ ΔVX ...”.

Δt :

In time or frequency measurement condition two vertical cursor lines are displayed. The measurement result is indicated as „ Δt ...” (time measurement) or „f...” (frequency measurement). **Please note item (35) 1/ Δt .**

NOTE:

For frequency measurement, the distance between the cursors must equal exactly one signal period.

In **XY** mode the timebase is switched off. Consequently time or frequency measurement is disabled.

(37) CURSOR - Center biased lever.

The active cursor line (in track mode: both lines) can be shifted in the required direction, until the graticule limits are reached. The directions are marked on the front panel and depend on the selected measurement (ΔV , Δt or $1/\Delta t = f$).

Which of two shift speeds is used, depends on how far the **CURSOR** knob is pressed. With slight knob pressure the cursor line(s) moves slowly. If the knob is pressed to the full extent the cursor moves fast. If the knob is released it automatically reverts to the center position and the cursor shift stops.

(38) CAL. - Pushbutton and concentric socket.

A squarewave signal of $0.2V_{pp} \pm 1\%$ is available from the socket for probe adjustment purposes.

The signal frequency depends on the pushbutton setting. If the pushbutton is released it is approx. 1kHz and can be switched over (depressed) to approx. 1MHz. The pulse duty factor may deviate from 1:1 and the frequency is not calibrated.

(39) CT - Pushbutton and banana jack.

Pressing the pushbutton switches the instrument over from oscilloscope to component test mode and vice versa. In component test mode, all controls are deactivated with the exception of the **CT** button, **AUTO SET (2)** and

INTENS (4). All LEDs except „A“ or „RO“ (associated with the **INTENS** knob) are dark. The readout displays only „CT“ in this condition.

One test lead is connected to the CT socket. The second test lead uses the ground socket (29). **Please note „Component Tester“.**

The maximum test voltage is approx. 20V_{pp} under open circuit conditions, while the max. test current under short circuit condition is approx. 20mA_{pp}.

Menu

The instrument software contains a menu. This menu allows changes to the default settings regarding the instrument behaviour during operation, and a calibration option.

The menu can be called in the following way. After the oscilloscope is switched on and warmed up, the **HAMEG** logo and the software version („Rel. xx“) are displayed.

To enter the menu press and hold the **AUTO SET** button constantly until the internal test is completed successfully. Then the readout displays the headline „MAIN MENU“ and the submenus „CALIBRATION“ and „SETUP“.

One of the submenus „CALIBRATION“ or „SETUP“ of the „MAIN MENU“ can be preselected by briefly pressing the **SAVE** or **RECALL** button (7). The preselected submenu will be highlighted and can be called by pressing and holding the **SAVE (SET)** button (7). Subsequently one of menu items in the submenu can be preselected by briefly pressing the **SAVE** or **RECALL** button (7). The preselected menu item will be highlighted. Pressing and holding the **SAVE (SET)** pushbutton either calls the function corresponding to the preselected menu item or switches the corresponding function from **ON** to **OFF** or vice versa.

item no 1: CONTROLS BEEP ON/OFF.

In OFF condition the acoustic signals actuated by the control limits are switched off.

item no 2: ERROR BEEP ON/OFF.

Acoustic signals indicating faulty control operation are suppressed in OFF condition.

Note: The default setting regarding items 1 and 2 is ON. If different conditions are required the setting must be performed each time after switching the oscilloscope on.

item no 3: QUICK START ON/OFF.

In condition **ON** the **HAMEG** logo and the menus will not be displayed after switching the instrument on. Then the instrument is quickly ready for operation. To change from **QUICK START ON** to **OFF**, press and hold the **AUTOSET** button when switching the instrument on until the menus become visible and change the setting.

The **ON/OFF** information is **not displayed** in the readout if one of the following items (4 to 6) is selected. After one of these items has been chosen, press and hold the **SAVE (SET)** function) pushbutton (7) to call the function. This causes a warning to be displayed. If the function was called erroneously it can be left by pressing the **AUTOSET** pushbutton (2). Otherwise press and hold the **SAVE (SET)** function) pushbutton (7) to enter the function.

item no 4: LOAD S/R DEFAULT (S/R = SAVE/RECALL).

This overwrites all **SAVE/RECALL** memories with the following instrument setting:

Single channel operation („Y1:500mV~“),
timebase („T:100µs“),
automatic peak value triggering and
AC trigger coupling.

item no 5: RESTORE FACTORY DEFAULT.

If inadvertently an adjustment was performed in **CALIBRATE MENU** condition, which was not stored by **OVERWRITE FACTORY DEFAULT**, the factory adjustments can be recalled by this function.

item no 6: OVERWRITE FACTORY DEFAULT.

Attention!

Calling this function causes the factory adjustments to be overwritten by new data. The factory adjustment then is lost and can not be recalled by RESTORE FACTORY DEFAULT.

This function is only intended for those cases in which an adjustment can be performed with very expensive 0% error calibrators, to adjust the instrument for optimum tolerance when operated under extreme environmental conditions.

First Time Operation

The following text assumes that the „SAFETY“ section of this manual has been read carefully and understood.

Each time before the instrument is put into operation check that the oscilloscope is connected to protective earth. For that reason the power cable must be connected to the oscilloscope and the power outlet. Then the test lead(s) must be connected to the oscilloscope input(s). Check that the device under test is switched off and connect the test lead(s) to the test point(s). Then switch on the instrument and afterwards the device under test.

The oscilloscope is switched on by depressing the red **POWER** pushbutton. After a few seconds the **HAMEG** logo and the instrument software release is displayed on the screen. As long as the **HAMEG** logo is visible different internal checks are made. Thereafter the instrument will revert to its last used operating mode.

If after approx. 20 seconds no trace is visible, the **AUTO SET** pushbutton should be pressed briefly. This selects the Yt mode and medium trace and readout intensity (**please note „AUTO SET“**). Adjust **Y-POS.I** and **X-POS.** controls to center the baseline. Adjust **INTENS.** (intensity) and **FOCUS** controls for medium brightness and optimum sharpness (input(s) grounded) of the trace. The oscilloscope is now ready for use.

If the **AUTO SET** function was not used and only a spot appears (CAUTION! CRT phosphor can be damaged), reduce the intensity immediately and check that the XY mode is not selected (XY not displayed in the readout).

To obtain the maximum life from the cathode-ray tube, the minimum intensity setting necessary for the measurement in hand and the ambient light conditions should be used.

Particular care is required when a single spot is displayed, as a very high intensity setting may cause damage to the fluorescent screen of the CRT. Switching the oscilloscope off and on at short intervals stresses the cathode of the CRT and should therefore be avoided.

The instrument is so designed that even incorrect operation will not cause serious damage.

First Time Operation

Trace Rotation TR

In spite of Mumetal-shielding of the CRT, effects of the earth's magnetic field on the horizontal trace position cannot be completely avoided. This is dependent upon the orientation of the oscilloscope on the place of work. A centred trace may not align exactly with the horizontal center line of the graticule. A few degrees of misalignment can be corrected by a potentiometer accessible through an opening on the front panel marked TR.

Probe compensation and use

To display an undistorted waveform on an oscilloscope, the probe must be matched to the individual input impedance of the vertical amplifier.

For this purpose a square wave signal with a very fast rise time and minimum overshoot should be used, as the sinusoidal contents cover a wide frequency range.

The built-in calibration generator provides a square wave signal with a very fast risetime (<4ns), and switch-selectable frequencies of approx. 1kHz and 1MHz from the output socket below the CRT screen.

As the square wave signals are used for probe compensation adjustments, neither the frequency accuracy nor the pulse duty factor are of importance and therefore not specified.

The output provides $0.2V_{pp} \pm 1\%$ ($t_r < 4ns$) for 10:1 probes. When the Y deflection coefficient is set to 5mV/div, the calibration voltage corresponds to a vertical display of 4 divisions (10:1 probe).

The output socket has an internal diameter of 4.9mm to accommodate the internationally accepted shielding tube diameter of modern Probes and F-series slimline probes. Only this type of construction ensures the extremely short ground connections which are essential for an undistorted waveform reproduction of non-sinusoidal high frequency signals.

Adjustment at 1kHz

The C-trimmer adjustment (low frequency) compensates the capacitive loading on the oscilloscope input. By this adjustment, the capacitive division assumes the same ratio as the ohmic voltage divider to ensure the same division ratio for high and low frequencies, as for DC. (For 1:1 probes or switchable probes set to 1:1, this adjustment is neither required nor possible). A baseline parallel to the horizontal graticule lines is essential for accurate probe adjustments. (See also „Trace rotation TR“).

Connect the probes (Types **HZ51**, **52**, **54**, or **HZ36**) to the **CH I** input. Set the deflection coefficient to 5mV/div and the input coupling to DC. The time deflection coefficient should be set to 0.2ms/div. All deflection coefficients should be calibrated. Plug the probe tip into the calibrator output socket.

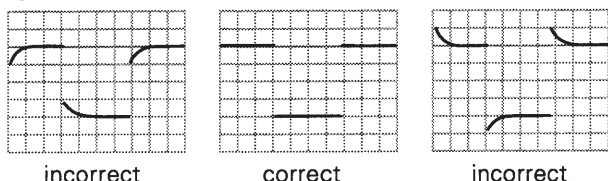

Approximately 2 complete waveform periods are displayed on the CRT screen. The compensation trimmer should be adjusted. The location of the low frequency compensation trimmer can be found in the probe information sheet. Adjust

the trimmer with the insulated screw driver provided, until the tops of the square wave signal are exactly parallel to the horizontal graticule lines (see 1kHz diagram). The signal height should then be $4div \pm 0.16div$ (= 4 % (oscilloscope 3% and probe 1%). During this adjustment, the signal edges will remain invisible.

Adjustment at 1MHz

Probes **HZ51**, **52** and **54** can also be HF-compensated. They incorporate resonance de-emphasizing networks (R-trimmer in conjunction with inductances and capacitors) which permit probe compensation in the range of the upper frequency limit of the vertical oscilloscope amplifier. Only this compensative adjustment ensures optimum utilisation of the full bandwidth, together with constant group delay at the high frequency end, thereby reducing characteristic transient distortion near the leading edge (e.g. overshoot, rounding, ringing, holes or bumps) to an absolute minimum.

Using the probes **HZ51**, **52** and **54**, the full bandwidth of the oscilloscope can be utilized without risk of unwanted waveform distortion.

Prerequisite for this HF compensation is a square wave generator with fast risetime (typically 4ns), and low output impedance (approx. 50Ω), providing 0.2V at a frequency of approx. 1MHz. The calibrator output of this instrument meets these requirements when the CAL. pushbutton is depressed.

Connect the probe to **CH.I** input. Depress the **CAL.** pushbutton for 1MHz. Operate the oscilloscope as described under 1kHz but select for 0.2 μ s/div time deflection coefficient setting. Insert the probe tip into the output socket. A waveform will be displayed on the CRT screen, with leading and trailing edges clearly visible. For the HF-adjustment now to be performed, it will be necessary to observe the rising edge as well as the upper left corner of the pulse top. The location of the high frequency compensation trimmer(s) can also be found in the probe information sheet. These R-trimmer(s) have to be adjusted such that the beginning of the pulse is as straight as possible. Overshoot or excessive rounding are unacceptable. The adjustment is relatively easy if only one adjusting point is present. In case of several adjusting points the adjustment is slightly more difficult, but causes a better result. The rising edge should be as steep as possible, with a pulse top remaining as straight and horizontal as possible.

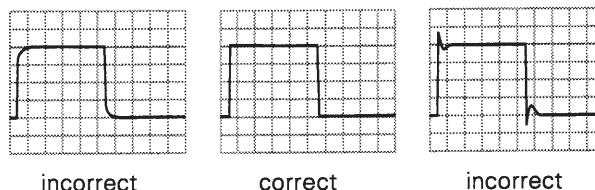

After completion of the HF-adjustment, the signal amplitude displayed on the CRT screen should have the same value as during the 1kHz adjustment.

Probes other than those mentioned above, normally have a larger tip diameter and may not fit into the calibrator output. Whilst it is not difficult for an experienced operator to build a suitable adapter, it should be pointed out that most of these probes have a slower risetime with the effect that the total bandwidth of scope together with probe may fall far below that of the oscilloscope. Furthermore, the HF-adjustment feature is nearly always missing so that waveform distortion can not be entirely excluded. The adjustment sequence must be followed in the order described, i.e. first at 1kHz, then at 1MHz. The calibrator frequencies should not be used for timebase calibration. The pulse duty cycle deviates from 1:1 ratio.

Operating modes of the vertical amplifiers in Yt mode

Prerequisites for precise and easy probe adjustments, as well as checks of deflection coefficients, are straight horizontal pulse tops, calibrated pulse amplitude, and zero-potential at the pulse base. Frequency and duty cycle are relatively unimportant. For interpretation of transient response, fast pulse risetimes and low-impedance generator outputs are of particular importance.

Providing these essential features, as well as switch-selectable output-frequencies, the calibrator of the instrument can, under certain conditions, replace expensive squarewave generators when testing or compensating wideband-attenuators or amplifiers. In such a case, the input of an appropriate circuit will be connected to the **CAL**-output via a suitable probe.

The voltage provided at a high-impedance input (1MΩ || 15-30pF) will correspond to the division ratio of the probe used (10:1 = 20mV_{pp} output). Suitable probes are **HZ51**, **52**, and **54**.

Operating modes of the vertical amplifiers in Yt mode.

The most important controls regarding the operation modes of the vertical amplifiers are the pushbuttons: **CHI (16)**, **DUAL (17)** and **CH II (20)**. Their functions are described in the section „Controls and Readout“.

In most cases oscilloscopes are used to display signals in Yt mode. Then the signal amplitude deflects the beam in vertical direction while the timebase causes an X deflection (from left to right) at the same time. Thereafter the beam becomes blanked and fly back occurs.

The following Yt operation modes are available:

- Single channel operation of channel I (Mono CH I).
- Single channel operation of channel II (Mono CH II).
- Two channel operation of channel I and channel II (DUAL).
- Two channel operation of channel I and channel II -displaying the algebraic result as the sum or difference - (ADD).

The way the channel switching is determined in **DUAL** mode depends on the timebase setting and is described in the section „Controls and Readout“.

In **ADD** mode the signals of both channels are algebraically added and displayed as one signal. Whether the resulting display shows the sum or difference is dependent on the phase relationship or the polarity of the signals and on the invert function.

In **ADD** mode the following combinations are possible for

In-phase input voltages:

- No invert function active = sum.
- Channel II invert function active = difference.

Antiphase input voltages:

- No invert function active = difference.
- Channel II invert function active = sum.

In the **ADD** mode the vertical display position is dependent upon the **Y-POS.** setting of both channels. The same Y deflection coefficient is normally used for both channels with algebraic addition.

Please note that the Y-POS. settings are also added but are not affected by the INV setting.

Differential measurement techniques allow direct measurement of the voltage drop across floating components (both ends above ground). Two identical probes should be used for

both vertical inputs. In order to avoid ground loops, use a separate ground connection and do not use the probe ground leads or cable shields.

X-Y Operation

The important control for this mode is the pushbutton labeled **DUAL** and **XY (17)**.

In **XY** mode the timebase is deactivated. The signal applied to the input of channel II - front panel marking **HOR. INP. (X)** - causes the X deflection. The input related controls (**AC/DC**, **GD** pushbutton and the **VOLTS/DIV** knob) consequently affect the X deflection. For X position alteration, the **X-POS.** control knob must be used, as the **Y-POS. II** control is automatically inactivated. The input deflection coefficient ranges are the same for both channels, because the **X x10** magnifier is inactive in **XY** mode.

The bandwidth of the X amplifier, is lower than the Y amplifier and the phase angle which increases with higher frequencies, must be taken into account (please note data sheet).

The inversion of the X-input signal is not possible.

Lissajous figures can be displayed in the X-Y mode for certain measuring tasks:

- Comparing two signals of different frequency or bringing one frequency up to the frequency of the other signal. This also applies for whole number multiples or fractions of the one signal frequency.
- Phase comparison between two signals of the same frequency.

Phase comparison with Lissajous figures

The following diagrams show two sine signals of the same frequency and amplitude with different phase angles.

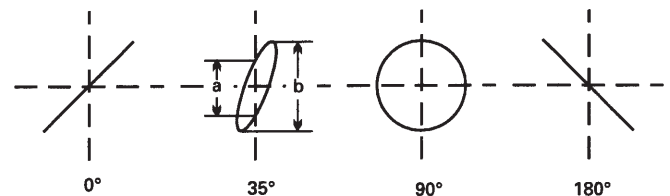

Calculation of the phase angle or the phase shift between the X and Y input voltages (after measuring the distances a and b on the screen) is quite simple with the following formula, and a pocket calculator with trigonometric functions. Apart from the reading accuracy, the signal height has no influence on the result.

$$\sin \varphi = \frac{a}{b}$$
$$\cos \varphi = \sqrt{1 - \left(\frac{a}{b}\right)^2}$$
$$\varphi = \arcsin \frac{a}{b}$$

The following must be noted here:

- Because of the periodic nature of the trigonometric functions, the calculation should be limited to angles $\leq 90^\circ$. However here is the advantage of the method.
- Due to phase shift, do not use a too high test frequency.
- It cannot be seen as a matter of course from the screen display if the test voltage leads or lags the reference voltage. A CR network before the test voltage input of the

Operating modes of the vertical amplifiers in Yt mode

oscilloscope can help here. The $1\text{M}\Omega$ input resistance can equally serve as R here, so that only a suitable capacitor C needs to be connected in series. If the aperture width of the ellipse is increased (compared with C short-circuited), then the test voltage leads the reference voltage and vice versa. This applies only in the region up to 90° phase shift. Therefore C should be sufficiently large and produce only a relatively small just observable phase shift.

Should both input voltages be missing or fail in the X-Y mode, a very bright light dot is displayed on the screen. This dot can burn into the phosphor at a too high brightness setting (INTENS. knob) which causes either a lasting loss of brightness, or in the extreme case, complete destruction of the phosphor at this point.

Phase difference measurement in DUAL mode (Yt)

Phase differences between two input signals of the same frequency and shape can be measured very simply on the screen in Dual mode. The timebase should be triggered by the reference signal (phase position 0). The other signal can then have a leading or lagging phase angle. In alternate triggering condition, phase difference measurement is not possible.

For greatest accuracy adjust the timebase for slightly over one period and approximately the same height of both signals on the screen. The Y deflection coefficients, the timebase coefficients and the trigger level setting can be used for this adjustment, without influence on the result. Both base lines are set onto the horizontal graticule center line using the Y-POS. knobs before the measurement. With sinusoidal signals, observe the zero (crossover point) transitions; the sine peaks are less accurate. If a sine signal is noticeably distorted by even harmonics, or if a DC voltage is present, AC coupling is recommended for both channels. If it is a question of pulses of the same shape, read off at steep edges.

It must be noted that the phase difference cannot be determined if alternate triggering is selected.

Phase difference measurement in DUAL mode

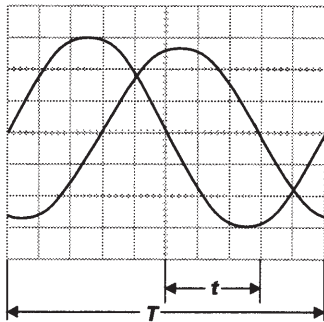

t = horizontal spacing of the zero transitions in div
 T = horizontal spacing for one period in div

In the example illustrated, $t = 3\text{div}$ and $T = 10\text{div}$. The phase difference in degrees is calculated from

$$\varphi^\circ = \frac{t}{T} \cdot 360^\circ = \frac{3}{10} \cdot 360^\circ = 108^\circ$$

or expressed in radians

$$\text{arc } \varphi^\circ = \frac{t}{T} \cdot 2\pi = \frac{3}{10} \cdot 2\pi = 1,885 \text{ rad}$$

Relatively small phase angles at not too high frequencies can be measured more accurately in the X-Y mode with Lissajous figures.

Measurement of an amplitude modulation

The momentary amplitude u at time t of a HF-carrier voltage, which is amplitude modulated without distortion by a sinusoidal AF voltage, is in accordance with the equation

$$u = U_T \cdot \sin\Omega t + 0,5m \cdot U_T \cdot \cos(\Omega - \omega) t - 0,5m \cdot U_T \cdot \cos(\Omega + \omega) t$$

where

- U_T = unmodulated carrier amplitude
- $\Omega = 2\pi F$ = angular carrier frequency
- $\omega = 2\pi f$ = modulation angular frequency
- m = modulation factor (i.a. $\infty 1$ 100%).

The lower side frequency $F-f$ and the upper side frequency $F+f$ arise because of the modulation apart from the carrier frequency F .

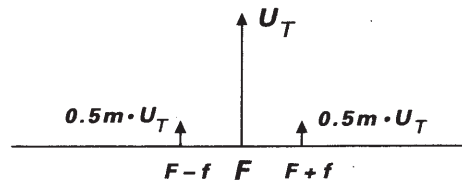

Figure 1: Amplitude and frequency spectrum for AM display ($m = 50\%$)

The display of an amplitude-modulated HF oscillation can be evaluated with the oscilloscope provided the frequency spectrum is inside the oscilloscope bandwidth. The timebase is set so that several cycles of the modulation frequency are visible. Strictly speaking, triggering should be external with modulation frequency (from the AF generator or a demodulator). However, internal triggering is frequently possible with normal triggering using a suitable trigger level setting and possibly also using the time vernier (variable) adjustment.

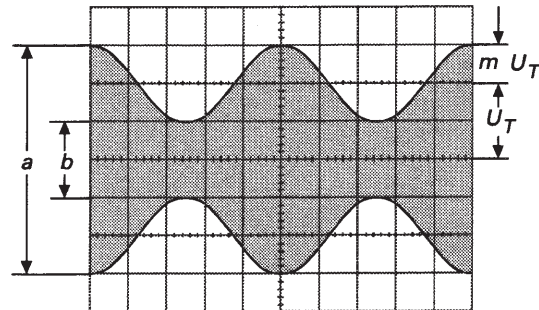

Figure 2: Amplitude modulated oscillator:

$F = 1 \text{ MHz}; f = 1 \text{ kHz};$
 $m = 50\%; U_T = 28.3 \text{ mVrms.}$

Oscilloscope setting for a signal according to figure 2:

- Y: CH. I; 20mV/div ; AC.
- TIME/DIV.: 0.2ms/div .
- Triggering: Normal; with LEVEL-setting; internal (or external) triggering.

If the two values a and b are read from the screen, the modulation factor is calculated from

$$m = \frac{a - b}{a + b} \quad \text{bzw.} \quad m = \frac{a - b}{a + b} \cdot 100\%$$

where

$$a = U_T (1+m) \quad \text{and} \quad b = U_T (1-m).$$

The variable controls for amplitude and time can be set arbitrarily in the modulation factor measurement. Their position does not influence the result.

Triggering and timebase

All controls regarding trigger and timebase are located on the right of the **VOLTS/DIV.** knobs. They are described in the section „Controls and Readout“.

Time related amplitude changes on a measuring signal (AC voltage) are displayable in Yt-mode. In this mode the signal voltage deflects the beam in vertical direction (Y) while the timebase generator moves the beam from the left to the right of the screen (time deflection = t).

Normally there are periodically repeating waveforms to be displayed. Therefore the timebase must repeat the time deflection periodically too. To produce a stationary display, the timebase must only be triggered if the signal height and slope condition coincide with the former timebase start conditions. A DC voltage signal can not be triggered as it is a constant signal with no slope.

Triggering can be performed by the measuring signal itself (internal triggering) or by an external supplied but synchronous voltage (external triggering).

The trigger voltage should have a certain minimum amplitude. This value is called the trigger threshold. It is measured with a sine signal. Except when external trigger is used the trigger threshold can be stated as vertical display height in div, at which the timebase generator starts, the display is stable, and the trigger indicator LED lights or flashes.

The internal trigger threshold of the oscilloscope is given as 5div. When the trigger voltage is externally supplied, it can be measured in Vpp at that input. Normally, the trigger threshold may be exceeded up to a maximum factor of 20.

The instrument has two trigger modes, which are characterized as Automatic Peak and Normal triggering.

Automatic Peak (value) -Triggering

Instrument specific informations can be drawn from the items **NM - AT - $\int \setminus$ (10)** and **LEVEL (12)** in the section „Controls and Readout“.

This trigger mode is automatically selected after the **AUTO SET** pushbutton was pressed. As the peak value detection makes no sense in combination with **DC** and **TV** (television) signals, it is switched off automatically in **DC**, **TVL** and **TVF** trigger coupling conditions as well as in alternate trigger mode. In this case the automatic is still present, but a wrong trigger level setting causes an untriggered display.

In automatic trigger mode the sweep generator can run without test signal or external trigger voltage. A base line will always be displayed even with no signal. With an applied AC signal the peak value triggering enables the user to select the voltage point on the trigger signal (trigger point), by the adjustment of the trigger level control. The control range depends on the peak to peak value of the signal. This trigger mode is therefore called Automatic Peak (Value)- Triggering. Operation of the scope needs only correct amplitude and timebase settings, for a constantly visible trace. Automatic mode is recommended for all uncomplicated measuring tasks. However, automatic triggering is also the appropriate operation mode for the „entry“ into difficult measuring problems, e.g. when the test signal is unknown relating to amplitude, frequency or shape. Presetting of all parameters is

now possible with automatic triggering; the change to normal triggering can follow thereafter.

The automatic triggering works above 20Hz. The failure of automatic triggering at frequencies below 20Hz is abrupt. However, it is not signified by the trigger indicator LED this is still blinking. Break down of triggering is best recognizable at the left screen edge (the start of the trace in differing display height).

The automatic peak (value) triggering operates over all variations or fluctuations of the test signal above 20Hz. However, if the pulse duty factor of a square-wave signal exceeds a ratio of 100:1, switching over to normal triggering will be necessary. Automatic triggering is practicable with internal and external trigger voltage.

Normal Triggering

Information specific to the instrument are given in the articles **NM - AT (10)**, **LEVEL (12)** and **TRIG. MODE (21)** in the section “Controls and Readout“. The time fine adjustment (**VAR.**) and the hold off time setting assist in triggering under specially difficult signal conditions. The following description refers to the **XY** mode.

With normal triggering, the sweep can be started by **AC** signals within the frequency range defined by the trigger coupling setting.

In the absence of an adequate trigger signal or when the trigger controls (particularly the trigger **LEVEL** control) are misadjusted, no trace is visible, i.e. the screen completely blanked.

When using the internal normal triggering mode, it is possible to trigger at any amplitude point of a signal edge, even with very complex signal shapes, by adjusting the trigger **LEVEL** control. If the signal applied at the Y input is used for triggering (internal trigger source), its adjusting range is directly dependent on the display height, which should be at least 0.5div. If it is smaller than 1div, the trigger **LEVEL** adjustment needs to be operated with a sensitive touch. In the external normal triggering mode, the same applies to approx. 0.3Vpp external trigger voltage amplitude.

Other measures for triggering of very complex signals are the use of the timebase variable control and **HOLD OFF** time control, hereinafter mentioned.

SLOPE $\int \setminus$

Please note item (10) in section „Controls and Readout“ for instrument specific information.

The actual slope setting is displayed in the readout. The setting is not changed by the **AUTO SET** function. The slope setting can be changed in delay mode for the delay timebase trigger unit if the delay trigger function is active. The previous slope setting for the undelayed timebase trigger is stored and still active. For further information please note „Controls and Readout“.

The timebase generator can be triggered by a rising or falling edge of the test signal. Whether the rising or the falling edge is used for triggering, depends on the slope direction setting. This is valid with automatic and normal triggering. The positive slope direction means an edge going from a negative potential and rising to a positive potential. This has nothing to do with zero or ground potential and absolute voltage values. The positive slope may also lie in a negative part of a signal.

However the trigger point may be varied within certain limits on the chosen edge using the **LEVEL** control. The slope

Triggering and timebase

direction is always related to the input signal and the non inverted display.

Trigger coupling

Instrument specific information regarding this item can be noted in the „Data Sheet“. The coupling setting (**TRIG. MODE (21)**) and indication are described under „Controls and Readout“.

As the automatic triggering does not work below 20Hz, normal triggering should be used in DC and LF trigger coupling mode. The coupling mode and accordingly the frequency range of the trigger signal should meet the signal requirements.

AC: This is the most frequently used trigger mode. The trigger threshold increases below and above the frequency limits mentioned in the data sheet. This filter cuts off both the DC content of the trigger signal and the lowest frequency range.

DC: In this coupling mode the trigger signal is coupled galvanically to the trigger. Therefore there is no low frequency limit.

DC triggering is recommended if the signal is to be triggered with quite slow processes or if pulse signals with constantly changing pulse duty factors have to be displayed.

HF: In this coupling mode the transmission range equals a high pass filter. It cuts off the DC content of the trigger signal and the lower frequency range.

LF: LF trigger coupling has a low pass filter characteristic. As in DC trigger coupling, there is no low limit for the pass frequency range (galvanic coupling) in connection with normal triggering. The trigger signal is coupled through a capacitor in the automatic (peak value) triggering and LF trigger coupling. This results in a low frequency limit which, however, does not disturb as the limit is below the repetition frequency of the trigger automatic.

The LF trigger coupling is often more suitable for low frequency signals than DC trigger coupling because the noise components of the trigger signals are strongly suppressed. This avoids or reduces, under borderline conditions, jitter or double traces especially with very low signal voltages. The trigger threshold raises continuously above the pass band.

TV-L: The built-in active TV-Sync-Separator provides the separation of line sync pulses from the video signal. Even distorted video signals are triggered and displayed in a stable manner. This mode is described under paragraph „Triggering of video signals“.

TV-F: The built-in active TV-Sync-Separator also provides the separation of frame sync pulses from the video signal. Even distorted video signals are triggered and displayed in a stable manner. This mode is described under paragraph „Triggering of video signals“.

Triggering of video signals

In **TV-L** and **TV-F** trigger coupling mode the instrument is automatically set to automatic triggering and the trigger point indicator is switched off. As only the separated synchronisation pulses are used for triggering the relationship between the displayed signal and the trigger signal is lost. In **TV-F** mode interference may occur if chopped **DUAL** mode is chosen or the readout is active.

Video signals are triggered in the automatic mode. The internal triggering is virtually independent of the display height, but the sync pulse must exceed 0.5div height.

The polarity of the synchronization pulse is critical for the slope selection. If the displayed sync pulses are above the picture (field) contents (leading edge positive going), then the slope setting for positive going edges must be chosen. In the case of sync pulses below the field/line, the leading edge is negative and consequently the slope selection must be set for falling edges. Since the invert function may cause a misleading display, it must not be activated.

On the 2ms/div setting and field **TV** triggering selected, 1 field is visible if a 50 fields/s signal is applied. If the hold off control is in fully ccw position, it triggers without line interlacing effects caused by the consecutive field.

The display can be expanded by switching on the **X-MAG. x10** function so that individual lines are recognizable. Commencing with a frame synchronizing pulse, the display can also be expanded with the knob **TIME/DIV**. But note that this can result in an apparently unsynchronized display as each frame (half picture) triggers. This is due to the off set of half a line between frames.

The influence of the integrating network which forms a trigger pulse from the vertical sync pulses may become visible under certain conditions. Due to the integrating network time constant not all vertical sync pulses starting the trace are visible.

On the 10µs/div setting and line TV triggering selected, approx. 1½ lines are visible. Those lines originate from the odd and even fields at random.

The sync-separator-circuit also operates with external triggering. It is important that the voltage range (0.3V_{pp} to 3V_{pp}) for external triggering should be noted. Again the correct slope setting is critical, because the external trigger signal may not have the same polarity or pulse edge as the test signal displayed on the CRT. This can be checked, if the external trigger voltage itself is displayed first (with internal triggering).

In most cases, the composite video signal has a high DC content. With constant video information (e.g. test pattern or color bar generator), the DC content can be suppressed easily by AC input coupling of the oscilloscope amplifier. With a changing picture content (e.g. normal program), DC input coupling is recommended, because the display varies its vertical position on screen with AC input coupling at each change of the picture content. The DC content can be compensated using the **Y-POS.** control so that the signal display lies in the graticule area. Then the composite video signal should not exceed a vertical height of 6div.

Line triggering (~)

The instrument specific information regarding this mode is part of the section „Controls and Readout“ paragraph **TRIG. MODE (21)**.

This trigger mode is present if the **~ LED** is lit (**21**). The trigger point symbol is inactive in line/mains trigger mode as there is no direct amplitude relationship between the trigger voltage and the signal voltage.

A voltage originating from mains/line (50 to 60Hz) is used for triggering purposes if the trigger coupling is set to **~**. This trigger mode is independent of amplitude and frequency of the Y signal and is recommended for all mains/line synchronous signals. This also applies within certain limits, to whole number multiples or fractions of the line frequency. Line

triggering can also be useful to display signals below the trigger threshold (less than 0.5div). It is therefore particularly suitable for measuring small ripple voltages of mains/line rectifiers or stray magnetic field in a circuit. In this trigger mode the slope direction pushbutton selects the positive or negative portion of the line/mains sinewave. The trigger level control can be used for trigger point adjustment.

Magnetic leakage (e.g. from a power transformer) can be investigated for direction and amplitude using a search or pick-up coil. The coil should be wound on a small former with a maximum of turns of a thin lacquered wire and connected to a BNC connector (for scope input) via a shielded cable. Between cable and BNC center conductor a resistor of at least 100Ω should be series-connected (RF decoupling). Often it is advisable to shield statically the surface of the coil. However, no shorted turns are permissible. Maximum, minimum, and direction to the magnetic source are detectable at the measuring point by turning and shifting the coil.

Alternate triggering

This trigger mode can be selected in **DUAL** mode by pressing and holding the **TRIG.** pushbutton (**18**) if the preconditions are met (*please note „Controls and Readout“*). In the case of chopped **DUAL** mode, selecting alternate trigger mode automatically sets the instrument to alternate **DUAL** mode.

Under **TV-L**, **TV-F** and **line/mains** triggering conditions alternate triggering can not be chosen. Thus only the following trigger coupling modes are available in alternate trigger mode: **AC**, **DC**, **HF** and **LF**. The trigger point symbol and the peak value detection (in automatic trigger mode) are internally inactivated.

With alternate triggering it is possible to trigger two signals which are different in frequency (asynchronous). In this case the oscilloscope must be operated in **DUAL** alternate mode and internal triggering each input signal must be of sufficient height to enable trigger. To avoid trigger problems due to different **DC** voltage components, **AC** input coupling for both channels is recommended.

The internal trigger source is switched in alternate trigger mode in the same way as the channel switching system in **DUAL** alternate mode, i.e. after each timebase sweep. Phase difference measurement is not possible in this trigger mode as the trigger level and slope setting are equal for both signals. Even with 180° phase difference between both signals, they appear with the same slope direction.

If signals are applied with a high frequency ratio (difference), the trace intensity then becomes reduced if the timebase is set to smaller time coefficients (faster sweep). This happens as the number of sweeps does not increase because it depends on the lower frequency signal, but with a faster sweep the phosphor becomes less activated.

External triggering

The external trigger input is activated with the aid of the **TRIG.** (**18**) pushbutton (see „Controls and Readout“), if the trigger coupling is not set to line/mains trigger coupling. Then the internal trigger source is deactivated. As the external trigger signal applied at the **TRIG. EXT** socket normally has no relation to the signal height of the displayed signal, the trigger point symbol is switched off. The external trigger voltage must have a minimum amplitude of 0.3V_{pp} and should not increase above 3V_{pp}. The input impedance of the **TRIG. EXT.** socket is approx. 1MΩ || 20pF.

The maximum input voltage of the input circuit is 100V (DC+peak AC).

The external trigger voltage may have a completely different form from the test signal voltage, but must be synchronous with the test signal. Triggering is even possible in certain limits with whole number multiples or fractions of the test frequency.

It must be noted that a different phase angle between the measuring and the triggering signal may cause a display not coinciding with the slope selection setting.

The trigger coupling selection can also be used in external triggering mode.

Trigger indicator „TR“

The following description applies to the „**TR**“ LED. *Please note item (11) under „Controls and Readout“.*

An LED on condition indicates that the trigger signal has a sufficient amplitude and the trigger level control setting is correct. This is valid with automatic and with normal triggering. By observing the trigger LED, sensitive trigger level adjustment is possible when normal triggering is used, particularly at very low signal frequencies. The indication pulses are of only 100ms duration.

Thus for fast signals the LED appears to glow continuously, for low repetition rate signals, the LED flashes at the repetition rate or at a display of several signal periods not only at the start of the sweep at the left screen edge, but also at each signal period.

In automatic triggering mode the sweep generator starts repeatedly without test signal or external trigger voltage. If the trigger signal frequency decreases the trigger automatic repetition frequency the sweep generator starts without awaiting the trigger pulse. This causes an untriggered display and a flashing trigger LED.

HOLD OFF-time adjustment

For instrument specific information please note **DEL.POS.** (**22**) in section „Controls and Readout“.

If it is found that a trigger point cannot be found on extremely complex signals, even after careful adjustment of the trigger level control, a stable display may often be obtained using the holdoff control. This facility varies the holdoff time between two sweep periods approx. up to the ratio 10:1. Pulses or other signal waveforms appearing during this off period cannot trigger the timebase.

Particularly with burst signals or aperiodic pulse trains of the same amplitude, the start of the sweep can be delayed until the optimum or required time.

A very noisy signal or a signal with a higher interfering frequency is at times displayed double. It is possible that trigger level adjustment only controls the mutual phase shift, but not the double display. The stable single display of the signal, required for evaluation, is easily obtainable by expanding the hold off time until one signal is displayed.

A double display is possible with certain pulse signals, where the pulses alternately show a small difference of the peak amplitudes. Only a very exact trigger level adjustment makes a single display possible. The use of the holdoff control simplifies the right adjustment.

After specific use the holdoff control should be reset into its calibration detent (fully ccw), otherwise the brightness of the display is reduced drastically. The function is shown in the following figures.

Triggering and timebase

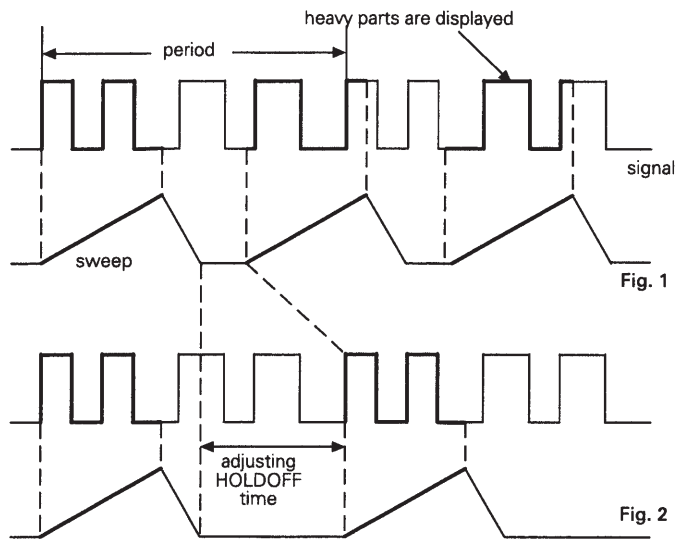

Fig. 1 shows a case where the holdoff control is in the minimum position and various different waveforms are overlapped on the screen, making the signal observation unsuccessful.

Fig. 2 shows a case where only the desired parts of the signal are stably displayed.

Delay / After Delay Triggering

The instrument specific information regarding this mode is part of the section „Controls and Readout“ paragraph **DEL.POS. (22)**, **SEA./DEL. (24)** and **DEL.TRIG. (25)**.

As mentioned before, triggering starts the time base sweep and unblanks the beam. After the maximum X deflection to the right, the beam is blanked and flies back to the (left) start position. After the hold off period the sweep is started automatically by the automatic trigger or the next trigger signal. In normal triggering mode the automatic trigger is switched off and will only start on receipt of a trigger signal.

As the trigger point is always at the trace start position, trace expansion in X direction with the aid of the timebase is limited to the display on the left of the trace. Parts of the signal to be expanded which are displayed near the trace end (right side of the screen) are lost when the timebase speed is increased (time coefficient reduced).

The delay function delays the trace start by a variable time from the trigger point. This allows the sweep to begin on any portion of a signal. The timebase speed can then be increased to expand the display in X direction. With higher expansion rates, the intensity reduces and within certain limits this can be compensated by the **INTENS** knob setting.

If the display shows jitter, it is possible to select for (second) triggering after the elapsed delay time (**DTR**). As mentioned before, it is possible to display video signals using the frame sync pulses for triggering (**TV-F**). After the delay time set by the operator, the next line sync pulse or the line content may be used for triggering. So data lines and test lines can be displayed separately.

Operation of the delay function is relatively simple. Without delay function set the time coefficient setting (**TIME/DIV**) until 1 to 3 signal periods are displayed. Display of less the one period should be avoided as it limits the selection of the signal section to be expanded, and may cause trigger problems.

The **X MAG (x10)** function should be switched off and the time variable control should be **CAL** position. The signal must

be triggered and stable. The following explanation assumes that the trace starts on the left vertical graticule line.

Photo 1
(composite video signal)

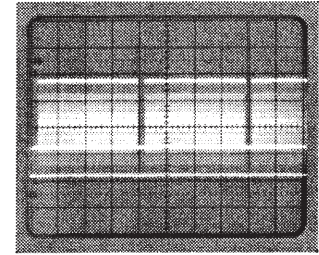

MODE: undelayed
TIME/DIV: 5ms/div
Trigger coupling: TV-F
Trigger slope: falling (-)

Pressing and holding the **SEA./DEL.** button switches over to **SEARCH** mode (**SEA** displayed by the readout).

In all delay modes, the **DEL. POS.** knob assumes the function of **DEL. POS.** (delay position), and the hold off time defaults to minimum. Now the function of this knob (**DEL. POS.**) is to adjust the delay time, indicated as a blanked part of the screen. The length of the blanked sector depends on the **DEL. POS.** setting and can be set between approx. two and seven division after the normal trace start position. As the trace right end is not effected, the visible trace length is reduced. In delay (**DEL**) mode, the trace will start from the normal left end where the blanking starts. If the maximum delay is not sufficient, the time coefficient must be increased (**TIME/DIV** knob) and the **DEL. POS.** knob set to the later starting point. To return to normal (undelayed) timebase operation, press and hold the **SEA./DEL** pushbutton again.

Photo 2

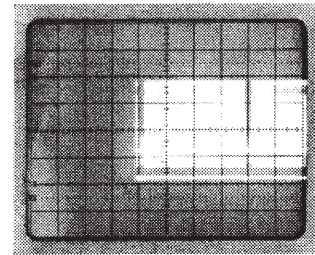

MODE: SEA (SEARCH)
TIME/DIV: 5ms/div
Trigger coupling: TV-F
Delay time:
4div x 5ms = 20ms

Figure 2 shows that the delay time can be measured. It is identical with the displacement of the start of the trace. One can calculate this by multiplying the blanked out section (horizontal) by the time deflection coefficient setting.

The total trace starting with the previously selected section will be visible when switched from **SEARCH** to **DELAY**, providing the (stored) current time deflection coefficient is not too small.

If the trace is invisible or hardly visible because of too high expansion (too small deflection coefficient), the time deflection coefficient must be increased with **TIME / DIV** knob. A larger deflection coefficient than in the **SEARCH** mode cannot be set.

Example:

The SEARCH setting selected in figure 2 is 5ms/cm. The display in DELAY mode, also with 5ms/cm is delayed but unexpanded (1:1). A further increase in the deflection coefficient, e.g. 10ms/cm would be meaningless and therefore automatically blocked.

Please note that the previous time coefficient chosen in **DEL** and **DTR** mode is stored and automatically set after activating one of those modes. If the stored time coefficient in **DEL** or **DTR** mode was higher than the actual value in **SEA** (search) mode, the time coefficient in **DEL** or **DTR** mode is automatically set to the value used during **SEA** (search) operation.

Photo 3

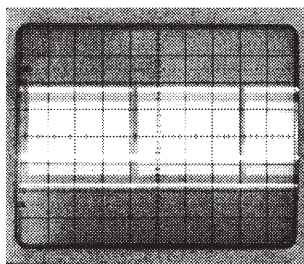

MODE: DEL (DELAY)
TIME/DIV: 5ms/div
Trigger coupling: TV-F
Trigger slope: falling (-)
Delay time: 20ms

Reducing the time coefficient (increasing the time base speed) now expands the signal. If the signal start position is not set to the optimum, it can still be shifted in the X direction by turning the **DEL. POS.** knob. Photo 4 shows a 50 fold X magnification caused by setting the time coefficient to 0.1ms/div (5ms/div : 0.1ms/div = 50). The reading accuracy also increases with higher X magnification. As already mentioned, the time variable control must be in **CAL** position when measurements are taken.

Photo 4

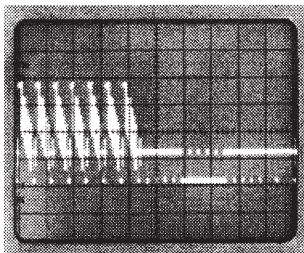

MODE: DEL (DELAY)
TIME/DIV: 0.1ms/div
Trigger coupling: TV-F
Trigger slope: falling (-)
Delay time: 20ms

The delayed and expanded signal display can be triggered again if a signal slope suitable for triggering appears after the delay time. For this, one must switch to **DEL.TRIG.** (2nd triggering after the expiry of the delay time - after Delay Triggering). The settings selected before switching, automatic Peak value triggering / Normal triggering, trigger coupling, the trigger **LEVEL** setting and slope setting, remain valid and trigger the start of the delay time.

The **"After Delay"** Triggering automatically switches to normal triggering (indicated by the **NM LED**) and DC trigger coupling. These default conditions cannot be changed. But the trigger level (**LEVEL**) and the trigger slope direction can be altered in order to enable the triggering at the desired signal section. The trace does not start and the screen remains blank if the signal amplitude is not sufficient for triggering or if the setting of the trigger **LEVEL** is unsuitable.

The expanded display can also be displaced in the X direction with **DELAY** position control (**DEL.POS.**) under suitable settings. However, the displacement is not continuous as in the untriggered **DELAY** operation but jumps from one trigger slope to another - with most signals this is not evident. This means, in the case of TV Triggering, that it is possible to trigger not only with line synchronizing pulses but also on suitable slopes occurring within the line.

Of course, the magnification is not restricted to a factor 50 as mentioned in the example. The limit is given by the increasing loss of trace intensity as the magnification is increased.

The manipulation of time delay requires a certain experience, especially with complicated signal combinations which are difficult to display. The recording of signal sections of simple signals is, in contrast, from the beginning fairly easy. The time delayed display is also possible in the dual channel, addition and difference modes.

Attention:

In combination of chopped DUAL mode and high expansion ratios in DELAY mode, chop interference

may be visible. This can be overcome by selecting alternate DUAL mode by briefly pressing simultaneously CH I and DUAL buttons.

AUTO SET

The instrument specific information regarding this function is part of the section „Controls and Readout“ paragraph **AUTO SET (2)**. As also mentioned in that section all controls are electronically selected with the exception of the **POWER** and calibrator frequency (CAL 1kHz/1MHz) pushbuttons as well as the **FOCUS** and **TR** (trace rotation) control.

Thus automatic signal related instrument set up in Yt (timebase) mode is possible. In most cases no additional manual instrument setting is required.

Briefly pressing the **AUTO SET** pushbutton causes the instrument to switch over to the last Yt mode settings regarding **CH I**, **CH II** and **DUAL**. If the instrument was operated in Yt mode, the actual setting will not be affected with the exception of **ADD** mode which will be switched off. At the same time the attenuator(s) (**VOLTS/DIV**) are automatically set for a signal display height of approx. 6 div in mono channel mode or if in **DUAL** mode for approx. 4 div height for each channel. This and the following explanation regarding the automatic time coefficient setting assumes that the pulse duty factor of the input signal is approx. 1:1.

The time deflection coefficient is also set automatically for a display of approx. 2 signal periods. The timebase setting occurs randomly if complex signals consisting several frequencies e.g. video signals are present.

AUTO SET sets the instrument automatically to the following operating conditions:

- AC input coupling
- Internal triggering (channel I or channel II)
- Automatic peak (value) triggering
- Trigger level in electrical midrange position
- Y deflection coefficient(s) calibrated
- Timebase deflection coefficient calibrated
- AC trigger coupling (except DC trigger coupling)
- SEARCH and DELAY timebase mode switched off
- X x10 magnifier switched off
- Automatic X and Y position settings
- Trace and readout visible.

If **DC** trigger coupling had been selected, **AC** trigger coupling will not be chosen and the automatic trigger is operative without the peak value detection.

The X position is set to the CRT centre as well as the Y position in **CH I** or **CH II** mode. In **DUAL** mode the channel I trace is set to the upper half and the channel II trace to the lower half of the CRT.

The 1mV/div and 2mV/div deflection coefficient will not be selected by **AUTO SET** as the bandwidth is reduced on these settings.

Attention!

If a signal is applied with a pulse duty factor of approx. 400:1 or larger, an automatic signal display can not be

performed. The pulse duty factor causes too low a Y deflection coefficient (sensitivity too high) and too high a time deflection coefficient (timebase speed to slow) and results in a display in which only the base-line is visible.

In such cases it is recommended to select normal triggering and to set the trigger point approx. 0.5div above or below the trace. If under one of these conditions the trigger indicator LED is lit, this indicates the presence of a signal. Then both the time coefficient and Y deflection coefficient should be reduced. Please note that a reduction in intensity may occur, which could result in a blank screen when the physical limits are reached.

SAVE/RECALL

The instrument specific information regarding the controls and their use are part of item (7) in section „Controls and Readout“.

The instrument contains a non volatile memory which can be used by the operator to save 9 different instrument settings and to recall them. This relates to all settings with the exception of **FOCUS, TR** (trace rotation) and the calibrator frequency pushbutton.

Component Tester

General

The instrument specific information regarding the control and terminals are part of item (39) in section „Controls and Readout“.

The instrument has a built-in electronic Component Tester, which is used for instant display of a test pattern to indicate whether or not components are faulty. It can be used for quick checks of semiconductors (e.g. diodes and transistors), resistors, capacitors, and inductors. Certain tests can also be made to integrated circuits. All these components can be tested individually, or in circuit provided that it is unpowered.

The test principle is fascinatingly simple. A built-in generator delivers a sine voltage, which is applied across the component under test and a built-in fixed resistor. The sine voltage across the test object is used for the horizontal deflection, and the voltage drop across the resistor (i.e. current through test object) is used for vertical deflection of the oscilloscope. The test pattern shows a current-voltage characteristic of the test object.

The measurement range of the component tester is limited and depends on the maximum test voltage and current (please note data sheet). The impedance of the component under test is limited to a range from approx. 20 Ω to 4.7k Ω . Below and above these values, the test pattern shows only short-circuit or open-circuit. For the interpretation of the displayed test pattern, these limits should always be born in mind. However, most electronic components can normally be tested without any restriction.

Using the Component Tester

After the component tester is switched on, the vertical preamplifier and the timebase generator are inoperative. A shortened horizontal trace will be observed. It is not necessary to disconnect scope input cables unless in-circuit measurements are to be carried out.

For the component connection, two simple test leads with 4mm \varnothing banana plugs, and with test prod, alligator clip or sprung hook, are required. The test leads are connected as described in section „Controls and Readout“.

Test Procedure

Caution!

Do not test any component in live circuitry - remove all grounds, power and signals connected to the component under test. Set up Component Tester as stated. Connect test leads across component to be tested. Observe oscilloscope display.

Only discharged capacitors should be tested!

Test Pattern Displays

The page „Test patterns“ shows typical patterns displayed by the various components under test.

- Open circuit is indicated by a straight horizontal line.
- Short circuit is shown by a straight vertical line.

Testing Resistors

If the test object has a linear ohmic resistance, both deflecting voltages are in the same phase. The test pattern expected from a resistor is therefore a sloping straight line. The angle of slope is determined by the resistance of the resistor under test. With high values of resistance, the slope will tend towards the horizontal axis, and with low values, the slope will move towards the vertical axis. Values of resistance from 20 Ω to 4.7k Ω can be approximately evaluated. The determination of actual values will come with experience, or by direct comparison with a component of a known value.

Testing Capacitors and Inductors

Capacitors and inductors cause a phase difference between current and voltage, and therefore between the X and Y deflection, giving an ellipse-shaped display. The position and opening width of the ellipse will vary according to the impedance value (at 50Hz) of the component under test.

A horizontal ellipse indicates a high impedance or a relatively small capacitance or a relatively high inductance.

A vertical ellipse indicates a small impedance or a relatively large capacitance or a relatively small inductance.

A sloping ellipse means that the component has a considerable ohmic resistance in addition to its reactance.

The values of capacitance of normal or electrolytic capacitors from 0.1 μ F to 1000 μ F can be displayed and approximate values obtained. More precise measurement can be obtained in a smaller range by comparing the capacitor under test with a capacitor of known value. Inductive components (coils, transformers) can also be tested. The determination of the value of inductance needs some experience, because inductors have usually a higher ohmic series resistance. However, the impedance value (at 50Hz) of an inductor in the range from 20 Ω to 4.7k Ω can easily be obtained or compared.

Testing Semiconductors

Most semiconductor devices, such as diodes, Z-diodes, transistors, FETs can be tested. The test pattern displays vary according to the component type as shown in the figures below.

The main characteristic displayed during semiconductor testing is the voltage dependent knee caused by the junction changing from the conducting state to the non conducting state. It should be noted that both the forward and the reverse characteristic are displayed simultaneously. This is a two-

terminal test, therefore testing of transistor amplification is not possible, but testing of a single junction is easily and quickly possible. Since the test voltage applied is only very low, all sections of most semi-conductors can be tested without damage. However, checking the breakdown or reverse voltage of high voltage semiconductors is not possible. More important is testing components for open or short-circuit, which from experience is most frequently needed.

Testing Diodes

Diodes normally show at least their knee in the forward characteristic. This is not valid for some high voltage diode types, because they contain a series connection of several diodes. Possibly only a small portion of the knee is visible. Zener diodes always show their forward knee and, depending on the test voltage, their zener breakdown forms a second knee in the opposite direction. If the breakdown voltage is higher than the positive or negative voltage peak of the test voltage, it can not be displayed.



Type: *Normal Diode* *Highvolt.-Diode* *Z-Diode 6.8V*
 Terminals: Cathode-Anode Cathode-Anode Cathode-Anode
 Connections: (CT-GD) (CT-GD) (CT-GD)

The polarity of an unknown diode can be identified by comparison with a known diode.

Testing Transistors

Three different tests can be made to transistors: base-emitter, base-collector and emitter-collector. The resulting test patterns are shown below.

The basic equivalent circuit of a transistor is a Z-diode between base and emitter and a normal diode with reverse polarity between base and collector in series connection. There are three different test patterns:



N-P-N Transistor
 Terminals: B-E B-C E-C
 Connections: (CT-GD) (CT-GD) (CT-GD)



P-N-P Transistor
 Pole: B-E B-C E-C
 Connections: (CT-GD) (CT-GD) (CT-GD)

For a transistor the figures b-e and b-c are important. The figure e-c can vary; but a vertical line only shows short circuit condition.

These transistor test patterns are valid in most cases, but there are exceptions to the rule (e.g. Darlington, FETs). With the **COMPONENT TESTER**, the distinction between a P-N-P to an N-P-N transistor is discernible. In case of doubt, comparison with a known type is helpful. It should be noted that the

same socket connection (**COMP. TESTER** or ground) for the same terminal is then absolutely necessary. A connection inversion effects a rotation of the test pattern by 180 degrees round about the center point of the scope graticule.

Pay attention to the usual caution with single MOS-components relating to static discharge or frictional electricity!

In-Circuit Tests

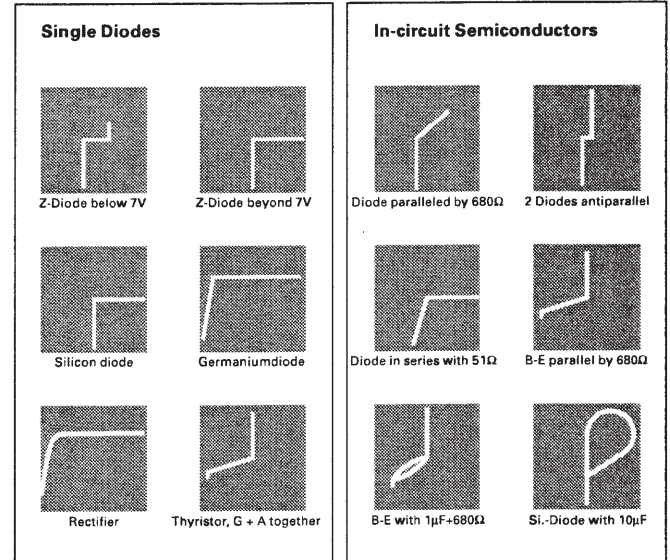

Caution!
During in-circuit tests make sure the circuit is dead. No power from mains/line or battery and no signal inputs are permitted. Remove all ground connections including Safety Earth (pull out power plug from outlet). Remove all measuring cables including probes between oscilloscope and circuit under test. Otherwise both COMPONENT TESTER leads are not isolated against the circuit under test.

In-circuit tests are possible in many cases. However, they are not well defined. This is caused by a shunt connection of real or complex impedances - especially if they are of relatively low impedance at 50Hz - to the component under test, often results differ greatly when compared with single components. In case of doubt, one component terminal may be unsoldered. This terminal should then not be connected to the ground socket avoiding hum distortion of the test pattern.

Another way is a test pattern comparison to an identical circuit which is known to be operational (likewise without power and any external connections). Using the test prods, identical test points in each circuit can be checked, and a defect can be determined quickly and easily. Possibly the device itself under test contains a reference circuit (e.g. a second stereo channel, push-pull amplifier, symmetrical bridge circuit), which is not defective.

Test Instructions

General

These Test Instructions are intended as an aid for checking the most important characteristics of the instrument at regular intervals without the need for expensive test equipment. Resulting corrections and readjustments inside the instrument, indicated by the following tests, are described in the „**Service Manual**“. They should only be undertaken by qualified personnel.

Test Procedure

A chargeable „**Service Manual**“ is available from **HAMEG**. The „**Service Manual**“ describes the complete adjustment of the instrument in english language and contains the circuit diagrams as well as the component locations.

As with the First Time Operation instructions, care should be taken that all variable functions are set to their calibrated positions. This is the case if **AUTO SET** had been pressed. It is recommended to switch on the instrument for about 20 minutes prior to the commencement of any check.

Cathode-Ray Tube: Brightness and Focus, Linearity, Raster Distortion

Normally, the **CRT** of the instrument has very good brightness. Any reduction of this brightness can only be judged visually. Decreased brightness may be the result of reduced high voltage. In this case the sensitivity of the vertical amplifiers is significantly increased .

The control range for maximum and minimum brightness (intensity) must be such that the beam just disappears before reaching the left hand stop of the **INTENS.** control (particularly when in **XY** mode), while with the control at the right hand stop the focus and the line width are just acceptable.

With maximum intensity the timebase fly-back must on no account be visible. Visible trace fault without input signal: bright dot on the left side or decreasing brightness from left to right or shortening of the baseline. (Cause: Incorrect Unblanking Pulse.) It should be noted that with wide variations in brightness, refocusing is always necessary. Moreover, with maximum brightness, no „pumping“ of the display must occur. If pumping does occur, it is normally due to a fault in the regulation circuitry for the high voltage supply. The presetting pots for the high voltage circuit, minimum and maximum intensity, are only accessible inside the instrument.

A certain out-of-focus condition in the edge zone of the screen must be accepted. It is limited by standards of the CRT manufacturer. The same is valid for tolerances of the orthogonality, the undeflected spot position, the non-linearity and the raster distortion in the marginal zone of the screen in accordance with international standards (see CRT data book). These limit values are strictly supervised by **HAMEG**. The selection of a cathode-ray tube without any tolerances is practically impossible.

Astigmatism Check

Check whether the horizontal and vertical sharpness of the display are equal. This is best seen by displaying a square-wave signal with the repetition rate of approximately 1MHz. Focus the horizontal tops of the square-wave signal at normal intensity, then check the sharpness of the vertical edges. If it is possible to improve this vertical sharpness by turning the **FOCUS** control, then an adjustment of the astigmatism control is necessary. A potentiometer of 47k Ω is provided inside the instrument for the correction of astigmatism. A certain loss of marginal sharpness of the CRT is unavoidable; this is due to the manufacturing process of the CRT.

Symmetry and Drift of the Vertical Amplifier

Both of these characteristics are substantially determined by the input stages of the amplifiers.

The symmetry of both channels and the vertical final amplifier can be checked by inverting. The vertical position of the trace should not change by more than 0.5div. However, a change of 1div is just permissible. Larger deviations indicate that changes have occurred in the amplifier.

A further check of the vertical amplifier symmetry is possible by checking the control range of the **Y-POS.** controls. A sine-wave signal of 10-100kHz is applied to the amplifier input. When the **Y-POS.** control is then turned fully in both directions from stop to stop with a display height of approximately 8div, the upper and lower positions of the trace that are visible should be approximately of the same height. Differences of up to 1div are permissible (input coupling should be set to AC).

Checking the drift is relatively simple. 20minutes after switching on the instrument, set the baseline exactly on the horizontal center line of the graticule. The beam position must not change by more than 0.5div during the following hour.

Calibration of the Vertical Amplifier

A square-wave voltage of 0.2V_{pp} \pm 1% is present at the output socket of the calibrator (**CAL.**) If a direct connection is made between the 0.2V output and the input of the vertical amplifier (e.g. using a x1 probe), the displayed signal in the 50mV/div position (variable control to **CAL.**) should be 4div high (**DC** input coupling). Maximum deviations of 0.12div (3%) are permissible. If a x10 probe (1%) is connected between the 0.2V output and Y input, the deflection coefficient should be set to 5mV/div. Then the maximum deviation is 0.16div.

With higher tolerances it should first be investigated whether the cause lies, within the amplifier or in the amplitude of the square-wave signal. On occasions it is possible that the probe is faulty or incorrectly compensated. If necessary the measuring amplifier can be calibrated with an accurately known **DC** voltage (**DC** input coupling). The trace position should then vary in accordance with the deflection coefficient set.

With variable control in the attenuator sector fully counter-clockwise, the input sensitivity is decreased at least by the factor 2.5 in each position. In the 50mV/div position, the displayed calibrator signal height should vary from 4div to at least 1.6div.

Transmission Performance of the Vertical Amplifier

The transient response and the delay distortion correction can only be checked with the aid of a square-wave generator with a fast risetime (max. 5ns). The signal coaxial cable (e.g. **HZ34**) must be terminated at the vertical input of the oscilloscope with a resistor equal to the characteristic impedance of the cable (e.g. with **HZ22**). Checks should be made at 100Hz, 1kHz, 10kHz, 100kHz and 1MHz, the deflection coefficient should be set at 5mV/div with **DC** input coupling. In so doing, the square pulses must have a flat top without ramp-off, spikes and glitches; no overshoot is permitted, especially at 1MHz and a display height of 4-5div. At the same time, the leading top corner of the pulse must not be rounded. In general, no great changes occur after the instrument has left the factory, and it is left to the operators discretion whether this test is undertaken or not. A suited generator for this test is **HZ60** from **HAMEG**.

Of course, the quality of the transmission performance is not only dependent on the vertical amplifier. The input attenuators, located in the front of the amplifier, are frequency-compensated in each position. Even small capacitive changes can reduce the transmission performance. Faults of this kind are as a rule most easily detected with a square-wave signal with a low repetition rate (e.g. 1kHz). If a suitable generator with max. output of 40V_{pp} is available, it is advisable to check at regular intervals the deflection coefficients on all positions of the input attenuators and readjust them as necessary. A compensated 2:1 series attenuator is also necessary, and this

must be matched to the input impedance of the oscilloscope. This attenuator can be made up locally. It is important that this attenuator is shielded. For local manufacture, the electrical components required are a $1\text{M}\Omega \pm 1\%$ resistor and, in parallel with it, a trimmer 3-15pF in parallel with approx. 10pF. One side of this parallel circuit is connected directly to the input connector of **CH I** or **CH II** and the other side is connected to the generator, if possible via a low-capacitance coaxial cable. The series attenuator must be matched to the input impedance of the oscilloscope in the 5mV/div position (variable control to **CAL.**, **DC** input coupling; square tops exactly horizontal; no ramp-off is permitted). This is achieved by adjusting the trimmer located in the 2:1 attenuator. The shape of the square-wave should then be the same in each input attenuator position.

Operating Modes: CH.I/II, DUAL, ADD, CHOP., INVERT and X-Y Operation

In **DUAL** mode two traces must appear immediately. On actuation of the **Y-POS.** controls, the trace positions should have minimal effect on each other. Nevertheless, this cannot be entirely avoided, even in fully serviceable instruments. When one trace is shifted vertically across the entire screen, the position of the other trace must not vary by more than 0.5mm.

A criterion in chopped operation is trace widening and shadowing around and within the two traces in the upper or lower region of the screen. Set time coefficient to 0.5ms/div, set input coupling of both channels to **GD** and advance the **INTENS.** control fully clockwise. Adjust **FOCUS** for a sharp display. With the **Y-POS.** controls shift one of the traces to a +2div, the other to a -2div vertical position from the horizontal center line of the graticule.

Do not try to synchronize (with the time variable control) the chop frequency (0.5MHz)! Check for negligible trace widening and periodic shadowing when switching between 0.5ms/div and 0.2ms/div.

It is important to note that in the I+II add mode or the I-II difference mode the vertical position of the trace can be adjusted by using both the Channel I and Channel II **Y-POS.** controls.

In X-Y Operation, the sensitivity in both deflection directions will be the same. When the signal from the built-in square-wave generator is applied to the input of Channel II, then, as with Channel I in the vertical direction, there must be a horizontal deflection of 4div when the deflection coefficient is set to 50mV/div position. The check of the mono channel display is unnecessary; it is contained indirectly in the tests above stated.

Triggering Checks

The internal trigger threshold is important as it determines the display height from which a signal will be stably displayed. It should be approx. 0.3-0.5div for the instrument. An increased trigger sensitivity creates the risk of response to the noise level in the trigger circuit. This can produce double-triggering with two out-of-phase traces.

Alteration of the trigger threshold is not required. Checks can be made with any sine-wave voltage between 50Hz and 1MHz. The instrument should be in automatic peak (value) triggering (**NM** LED dark) and the **LEVEL** knob in electrical midrange position. It should be ascertained whether the same trigger sensitivity is also present with Normal Triggering (**NM** LED lights). In this trigger mode, **LEVEL** adjustment is absolutely necessary.

The checks should show the same trigger threshold with the same frequency. On changing the trigger slope, the start of the sweep changes from the positive-going to the negative-going edge of the trigger signal.

As described in the Operating Instructions, the trigger frequency range is dependent on the trigger coupling selected. For lower frequencies the LF coupling mode can be selected. In this mode, triggering up to at least 1.5kHz (sine-wave) is possible. Internally the instrument should trigger perfectly at a display height of approx. 0.5div, when the appropriate trigger coupling mode is set.

For external triggering, the external trigger input connector requires a signal voltage of at least $0.3V_{pp}$, which is in synchronism with the Y input signal. The voltage value is dependent on the frequency and the trigger coupling mode (**AC-DC-HF-LF**).

Checking of the TV triggering is possible with a video signal of any given polarity.

Use the **TV-L** or **TV-F** setting for video sync pulse separation. The correct slope of the sync pulse (front edge) must be selected and a suitable time coefficient setting must be chosen. The slope is then valid for both sync frequencies.

Perfect **TV** triggering is achieved, when in both display modes the amplitude of the complete TV signal (from white level to the top of the line sync pulse) is limited between 0.8 and 6div and sync pulses of more than 0.5 div height. The display should not shift horizontally during a change of the trigger coupling from **AC** to **DC** when displaying a sine-wave signal without **DC** offset.

If both vertical inputs are AC coupled to the same signal and both traces are brought to coincide exactly on the screen, when working in the alternate dual channel mode, then no change in display should be noticeable, when switching from **TRIG CHI** to **TRIG CHII** or when the trigger coupling is changed from **AC** to **DC**.

Checking of the line/mains frequency triggering (50-60Hz) is possible, when the input signal is time-related (multiple or submultiple) to the power line frequency (\sim LED lights). There is no trigger threshold visible in this trigger mode. Even very small input signals are triggered stably (e.g. ripple voltage). For this check, use an input of approx. 1V. The displayed signal height can then be varied by turning the respective input attenuator switch and its variable control.

Timebase

Before checking the timebase it should be ascertained that the trace length is approx. 10div in all time ranges. The **X-MAG. x10** LED should not light. This condition should be maintained until the variation ranges of these controls are checked. Check that the sweep runs from the left to the right side of the screen (**TIME/DIV.** setting to 100ms/div). This check is only necessary after changing the cathode-ray tube.

If a precise marker signal is not available for checking the Timebase time coefficients, then an accurate sine-wave generator may be used. Its frequency tolerance should not be greater than $\pm 0.1\%$. The timebase accuracy of the instrument is given as $\pm 3\%$, but it is considerably better than this. For the simultaneous checking of timebase linearity and accuracy at least 10 oscillations, i.e. 1 cycle every div, should always be displayed. For precise determination, set the peak of the first marker or cycle peak exactly behind the first vertical graticule line using the **X-POS.** control. Deviation tendencies can be noted after some of the marker or cycle peaks. If a precise Time

Service Instruction

Mark Generator is used for checking, Normal Triggering and **LEVEL** control adjustment is recommended.

The signal frequency required for each time coefficient setting can be determined easily by the aid of the readout. In time measurement condition the distance of the vertical cursor lines must be set to exactly 1 div. Then both readout information regarding the time deflection coefficient and the time difference show exactly the same value. After switching over from time to frequency measurement, the readout displays the required signal frequency in each timebase setting.

Hold Off time

The variation of the hold off time setting can not be measured without opening the instrument. However, a visual check can be made if the instrument is operated in undelayed timebase mode. Without an input signal, set time base to 50ns/div, use automatic peak (value) triggering. With minimum hold off time the trace should be bright. It should noticeably darken if the hold off time is increased to the maximum.

Component Tester

After selecting component tester mode, a horizontal straight line should appear immediately, when the test leads are not connected (open circuit). The length of this trace should be approx. 8div. With the test leads shorted together, a vertical straight line with approx. 6div height should be displayed. The above stated measurements have some tolerances.

Trace Alignment

The CRT has an admissible angular deviation $\pm 5^\circ$ between the X deflection plane D1-D2 and the horizontal center line of the internal graticule. This deviation, due to tube production tolerances (and only important after changing the CRT), and also the influence of the earths magnetic field, which is dependent on the instruments North orientation, are corrected by means of the TR potentiometer. In general, the trace rotation range is asymmetric. It should be checked, whether the baseline can be adjusted somewhat sloping to both sides round about the horizontal center line of the graticule. With the instrument in its closed case, an angle of rotation $\pm 0.57^\circ$ (0.1div difference in elevation per 10div graticule length) is sufficient for the compensation of the earths magnetic field.

Service Instructions

General

The following instructions are intended as an aid for the electronic technician, who is carrying out readjustments on the instrument, if the nominal values do not meet the specifications. These instructions primarily refer to those faults, which were found after using the Test Instructions. However, this work should only be carried out by properly qualified personnel. For any further technical information call or write to **HAMEG**. Addresses are provided at the back of the manual. It is recommended to use only the original packing material, should the instrument be shipped to for service or repair (see also Warranty).

Instrument Case Removal

The rear cover can be taken off after unplugging the power cords triple-contact connector and after two nuts have been removed. If a cross recessed pan head screw is present on the bottom of the instrument, it must be removed too. While the instrument case is firmly held, the entire chassis with its front panel can withdrawn forward. When the chassis is

inserted into the case later on, it should be noticed that the case has to fit under the flange of the front panel. The same applies for the rear of the case, on which the rear cover is put.

Caution !

During opening or closing of the case, the instrument must be disconnected from all power sources for maintenance work or a change of parts or components. If a measurement, trouble-shooting, or an adjustment is unavoidable, this work must be done by a specialist, who is familiar with the risk involved.

When the instrument is set into operation after the case has been removed, attention must be paid to the acceleration voltage for the CRT approx. -2025V and to the operating voltages for both final amplifier stages 175V and 146V. Potentials of these voltages are on the PS-Board, the CRT-PCB and on the main PCB. They are highly dangerous and therefore precautions must be taken. It should be noted furthermore that shorts occurring on different points of the CRT high voltage and unblanking circuitry will definitely damage some semiconductors. For the same reason it is very risky to connect capacitors to these points while the instrument is on.

Capacitors in the instrument may still be charged, even when the instrument is disconnected from all voltage sources. Normally, the capacitors are discharged approx. 6 seconds after switching off. However, with a defective instrument an interruption of the load is not impossible. Therefore, after switching off, it is recommended to connect one by one all terminals across 1k Ω to ground (chassis) for a period of 1 second.

Caution

Handling of the CRT needs utmost caution. The glass bulb must not be allowed under any circumstances to come into contact with hardened tools, nor should it undergo local superheating (e.g. by soldering iron) or local undercooling (e.g. by cryogenic-spray). We recommend the wearing of safety goggles (implosion danger).

If any work has been carried out, the complete instrument (with case closed and **POWER** button depressed) must undergo a safety test, including a voltage test with 2200V DC, between accessible parts to both mains/line supply terminals. This test is dangerous and requires an adequately trained specialist. The maximum impedance between each accessible metallic part and the safety earth connector at the 3-pole power connector must be less than 0.1 Ω .

Operating Voltages

The operating voltages (+12V, -6V, -2025V) are stabilized by the switch mode power supply.

The +12V supply is further stabilized and used as a reference voltage for -6V stabilisation. These different operating voltages are fixed voltages, except the +12V, which can be adjusted. The variation of the fixed voltages greater than 5% from the nominal value indicates a fault. Measurements of the high voltage may only be accomplished by the use of a sufficient highly resistive voltmeter (>10M Ω). You must make absolutely sure that the electric strength of the voltmeter is sufficiently high. It is recommended to check the ripple and also the interaction from other possible sources. Excessive values might be very often the reason for incomprehensible faults.

Maximum and Minimum Brightness

A variable resistor (100k Ω), located on the **CRT PCB**, is used for this adjustment procedure. It may only be touched by a

properly insulating screwdriver (Caution! High voltage!). Correct adjustment is achieved, when the trace can be blanked in XY mode and, in addition, when the requirement described in the Test Instructions are met.

Astigmatism control

The ratio of vertical and horizontal sharpness can be adjusted by the variable resistor of 47k Ω , located on the **CRT PCB**. As a precaution however, the voltage for the vertical deflecting plates (approx. +71V when the trace is in center position) should firstly be checked, because this voltage will affect the astigmatism correction. While the adjustment is being carried out (with medium brightness and a 1MHz square-wave signal), the upper horizontal square-wave tops are firstly focussed with the **FOCUS** control. Then the sharpness of the vertical lines are corrected with the 47k Ω Astigm. pot. The correction should be repeated several times in this sequence. The adjustment is optimised, when the FOCUS knob exclusively brings no improvement of the sharpness in both directions.

Trigger Threshold

The internal trigger threshold should be in the range 0.3 to 0.5div display height.

Trouble-Shooting the Instrument

For this job, at least an isolating variable mains/line transformer (protection class II), a signal generator, an adequate precise multimeter, and, if possible, an oscilloscope are needed. This last item is required for complex faults, which can be traced by the display of signal or ripple voltages. As noted before, the regulated high voltage and the supply voltages for the final stages are highly dangerous. Therefore it is recommended to use totally insulated extended probe tips, when trouble-shooting the instrument. Accidental contact with dangerous voltage potentials is then unlikely. Of course, these instructions cannot thoroughly cover all kinds of faults. Some common-sense will certainly be required, when a complex fault has to be investigated.

If trouble is suspected, visually inspect the instrument thoroughly after removal of the case. Look for loose or badly contacted or discolored components (caused by overheating). Check to see that all circuit board connections are making good contact and are not shorting to an adjacent circuit. Especially inspect the connections between the PCBs. This visual inspection can lead to success much more quickly than a systematic fault location using measuring instruments. Prior to any extensive trouble-shooting, also check the external power source.

If the instrument fails completely, the first and important step - after checking the power fuses - will be to measure the deflecting plate voltages of the CRT. In almost any case, the faulty section can be located. The sections represent:

1. Vertical deflection.
2. Horizontal deflection.
3. CRT circuit.
4. Power supply.

While the measurement takes place, the position controls of both deflection devices must be in mid-position. When the deflection devices are operating properly, the separate voltages of each plate pair are almost equal then (Y approx. 71V and X approx 90V). If the separate voltages of a plate pair are very different, the associated circuit must be faulty. An absent trace in spite of correct plate voltages means a fault in the CRT circuit. Missing deflection plate voltages is probably caused by a defect in the power supply.

Adjustments

As advised in the Operating, Test and Service Instructions, small corrections and adjustments are easily carried out with the aid of the „Service Manual“. However, a complete recalibration of the scope should not be attempted by an inexperienced operator, but only someone with sufficient expertise. Several precision measuring instruments with cables and adapters are required, and only then should the pots and trimmers be readjusted, provided that the result of each adjustment can be exactly determined. Thus for each operating mode and switch position, a signal with the appropriate sine or square waveform, frequency, amplitude, risetime and duty cycle is required.

As described in the „Menu“ section, the instrument's software contains the submenu „**CALIBRATE**“. The following items can be used by operators not equipped with precision instruments.

After the required warm-up time of 20 minutes, first the instrument must be switched off and on again with the **AUTO SET** button pressed constantly until the main menu becomes visible. In the „**CALIBRATE**“ submenu the following items can be chosen:

- Y AMP (amplifier channel I and II)
- TRIGGER AMP (trigger amplifier channel I and II)

Attention!

During the automatic adjustment procedure no signal may be applied on any input.

Information for calling calibration functions is given in **MENU** section.

The new adjustment values are always present after the instrument is switched on. Therefore it is not required to overwrite the factory adjustments by calling the **OVERWRITE FACTORY DEFAULT** function in the **SETUP** menu.

Note!

The automatic adjustment should only be made if the instrument's warm up time has passed and no faults such as incorrect operating voltages are present. During the automatic adjustment procedures the readout indicates „Working“.

RS232 Interface - Remote Control

Safety

Caution:

All terminals of the RS232 interface are galvanically connected with the oscilloscope and subsequently with protective (safety) earth potential.

Measurement on a high level reference potential is not permitted and endangers operator, oscilloscope, interface and peripheral devices.

In case of disregard of the safety warnings contained in this manual, **HAMEG** refuses any liability regarding personal injury and/or damage of equipment.

Operation

The oscilloscope is supplied with a serial interface for control purposes. The interface connector (9 pole D- SUB female) is located on the rear of the instrument. Via this bidirectional port, the instrument parameter settings can be transmitted to, or received from a PC.

RS-232 Interface

RS-232 Cable:

The maximum connecting cable length must not exceed 3 meters and must contain 9 lines connected 1:1. The oscilloscope RS232 connection (9 pole D-SUB female) is determined as follows:

Pin

- 2 Tx data (data from oscilloscope to external device)
- 3 Rx data (data from external device to oscilloscope)
- 7 CTS (clear to send)
- 8 RTS (request to send)
- 5 Ground (reference potential - connected via the oscilloscope's power cord with protective earth)
- 9 +5V supply voltage for external devices (max. 400mA)

The maximum voltage swing at pin 2, 3, 7 and 8 is ± 12 Volt.

RS-232 protocol.

N-8-2 (no parity bit, 8 data bits, 2 stop bits, RTS/CTS hardware protocol).

Baud-Rate Setting

After the first **POWER UP** (switching on of the oscilloscope) and the first command **SPACE CR** (20hex, 0Dhex) sent from the PC, the baud rate is recognized and set automatically between 110 baud and 19200 baud. The oscilloscope is then switched over to **REMOTE** control mode. The oscilloscope

then transmits the **RETURNCODE: 0 CR LF** to the **PC**. In this status all settings (with the exception of those functions mentioned under „Controls and Readout“) can be controlled via the interface only.

The only ways to quit this status are:

- Switching the oscilloscope off, or transmitting the command
- **RM= 0** from the PC to the oscilloscope, or
- depressing the **AUTO SET (LOCAL)** pushbutton, if in unlocked condition (command LK=1... was not sent)

After the remote state has been switched off the **RM**-LED is dark.

Please note:

A minimum time must elapse between the commands RM=1... (remote on) and RM=0... (remote off) and vice versa. The time can be calculated with the formula:

$$t_{min} = 2x(1/baud\ rate) + 60\mu s.$$

If at the beginning no **SPACE CR** command is recognizable, the oscilloscope pulls the TxD line low for approx. 0.2ms and causes a break on the PC.

Data Communication

After successfully being set to remote control mode, the oscilloscope is prepared for command reception.

Front Panel HM404

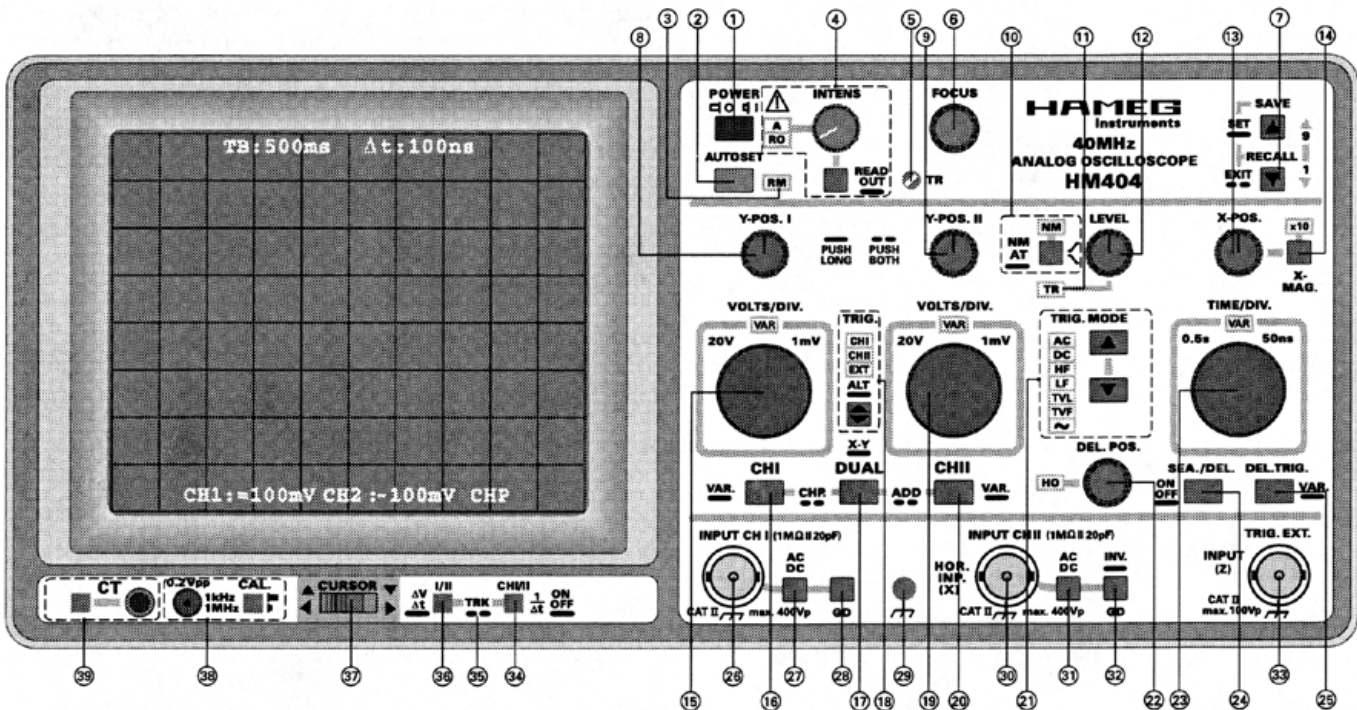

HAMEG[®]

Instruments

Oscilloscopes
Multimeters
Counters
Frequency
Synthesizers
Generators
R- and LC-
Meters
Spectrum
Analyzers
Power Supplies
Curve Tracers
Time Standards

Germany

HAMEG GmbH

Kelsterbacher Str. 15-19
60528 FRANKFURT am Main
Tel. (069) 67805 0
Telefax (069) 6780513

France

HAMEG S.a.r.l

5-9, av. de la République
94800-VILLEJUIF
Tél. (1) 4677 8151
Telefax (1) 4726 3544

Spain

HAMEG S.L.

Villarroel 172-174
08036 BARCELONA
Teléf. (93) 4301597
Telefax (93) 3212201

Great Britain

HAMEG LTD

74-78 Collingdon Street
LUTON Bedfordshire LU1 1RX
Phone (01582)413174
Telefax (01582)456416

United States of America

HAMEG, Inc.

1939 Plaza Real
OCEANSIDE, CA 92056
Phone (760) 630 4080
Telefax (760) 630 6507

HAMEG, Inc.

266 East Meadow Avenue
EAST MEADOW, NY 11554
Phone (516) 794 4080
Toll-free (800) 247 1241
Telefax (516) 794 1855

Hongkong

HAMEG LTD

Flat E, 20/F.
Capital Trade Centre,
62, Tsun Yip Street, Kwun Tong,
Kowloon, Hong Kong
Phone (852) 2 793 0218
Telefax (852) 2 763 5236